

DeltaSol® CS Plus

Version 1.11

Solar controller
Manual for the
specialised craftsman
Installation
Operation
Functions and options
Troubleshooting



11202673



The Internet portal for easy and secure access to your system data – www.vbus.net

Thank you for buying this RESOL product.
Please read this manual carefully to get the best performance from this unit.
Please keep this manual carefully.

en

Manual
www.resol.com

Safety advice

Please pay attention to the following safety advice in order to avoid danger and damage to people and property.

Instructions

Attention must be paid to the valid local standards, regulations and directives!

Information about the product

Proper usage

The solar controller is designed for electronically controlling standard solar thermal systems in compliance with the technical data specified in this manual.

Improper use excludes all liability claims.

CE Declaration of conformity

The product complies with the relevant directives and is therefore labelled with the CE mark. The Declaration of Conformity is available upon request, please contact the manufacturer.



Note

Strong electromagnetic fields can impair the function of the controller.

- Make sure the controller as well as the system are not exposed to strong electromagnetic fields.

Subject to technical change. Errors excepted.

Target group

These instructions are exclusively addressed to authorised skilled personnel.

Only qualified electricians should carry out electrical works.

Initial installation must be effected by the system owner or qualified personnel named by the system owner.

Description of symbols

WARNING! Warnings are indicated with a warning triangle!



→ **They contain information on how to avoid the danger described.**

Signal words describe the danger that may occur, when it is not avoided.

- **WARNING** means that injury, possibly life-threatening injury, can occur
- **ATTENTION** means that damage to the appliance can occur



Note

Notes are indicated with an information symbol.

→ Arrows indicate instruction steps that should be carried out.

Disposal

- Dispose of the packaging in an environmentally sound manner.
- Dispose of old appliances in an environmentally sound manner. Upon request we will take back your old appliances bought from us and guarantee an environmentally sound disposal of the devices.

The DeltaSol® CS Plus has been especially developed for the speed control of high-efficiency pumps in standard solar and heating systems.

It is equipped with two PWM outputs and an additional input for a VFD Grundfos Direct Sensor™ that enables a precise heat quantity measurement.

The commissioning menu will lead you through the most important adjustments for the initial configuration in only eight steps.

Contents

1	Overview	4
2	Installation	5
2.1	Mounting	5
2.2	Electrical connection	5
2.3	VFD Grundfos Direct Sensor™	6
2.4	PWM outputs	6
2.5	Data communication / Bus	6
2.6	System overview	7
2.7	Systems	8
3	Operation and function	46
3.1	Buttons	46
4	System-Monitoring-Display	46
4.1	Flashing codes	47
5	Commissioning	48
6	Channel overview	50
6.1	Display channels	50
6.2	Adjustment channels	53
7	Troubleshooting	64
8	Accessories	67
8.1	Sensors and measuring instruments	68
8.2	VBus® accessories	68
8.3	Interface adapters	68
9	Index	69

1 Overview

- Especially designed for the speed control of high-efficiency pumps
- 1 input for a VFD Grundfos Direct Sensor™
- System-Monitoring-Display
- Up to 4 Pt1000 temperature sensors
- 2 semiconductor relays for pump speed control
- HE pump control
- Heat quantity measurement
- Commissioning menu
- 10 basic systems to choose from
- Function control
- Optional thermal disinfection function
- Drainback option
- Unit °F and °C selectable

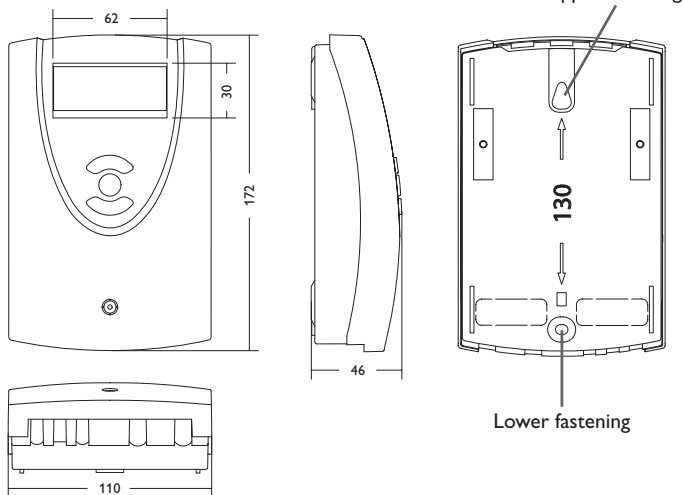

Technical data

Inputs: 4 Pt1000 temperature sensors, 1 VFD Grundfos Direct Sensor™

Outputs: 2 semiconductor relays, 2 PWM outputs

PWM frequency: 512 Hz

PWM voltage: 10.5 V

Switching capacity: 1 (1) A 240 V~ (semiconductor relay)

Total switching capacity: 2 A 240 V~

Power supply: 100 ... 240 V~ (50 ... 60 Hz)

Supply connection: type Y attachment

Standby: 0.59 W

Temperature controls class: I

Energy efficiency [%]: 1

Mode of operation: type 1.C.Y action

Rated impulse voltage: 2.5 kV

Data interface: RESOL VBus®

VBus® current supply: 35 mA

Functions: function control, operating hours counter, tube collector function, thermostat function, speed control and heat quantity measurement

Housing: plastic, PC-ABS and PMMA

Mounting: wall mounting, mounting into patch panels is possible

Indication/Display: System-Monitoring-Display for visualisation of systems, 16-segment and 7-segment display, 8 symbols for indication of system status

Operation: 3 push buttons at the front

Ingress protection: IP 20 / EN 60529

Protection class: I

Ambient temperature: 0 ... 40 °C

Pollution degree: 2

Dimensions: 172 x 110 x 46 mm

2 Installation

2.1 Mounting

WARNING! Electric shock!



Upon opening the housing, live parts are exposed!

→ **Always disconnect the device from power supply before opening the housing!**

i Note

Strong electromagnetic fields can impair the function of the controller.

→ Make sure the controller as well as the system are not exposed to strong electromagnetic fields.

The unit must only be located in dry interior rooms.

The controller must additionally be supplied from a double pole switch with contact gap of at least 3 mm.

Please pay attention to separate routing of sensor cables and mains cables.

In order to mount the device to the wall, carry out the following steps:

- Unscrew the crosshead screw from the cover and remove it along with the cover from the housing.
- Mark the upper fastening point on the wall. Drill and fasten the enclosed wall plug and screw leaving the head protruding.
- Hang the housing from the upper fastening point and mark the lower fastening point (centres 130 mm).
- Insert lower wall plug.
- Fasten the housing to the wall with the lower fastening screw and tighten.
- Carry out the electrical wiring in accordance with the terminal allocation (see chapter 2.2).
- Put the cover on the housing.
- Attach with the fastening screw.

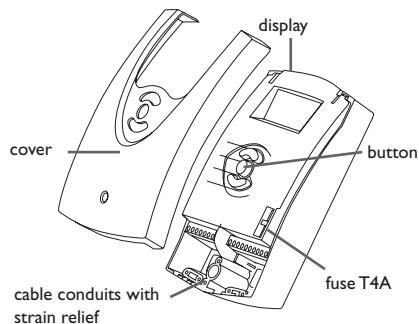

2.2 Electrical connection

WARNING! ESD damage!



Electrostatic discharge can lead to damage to electronic components!

→ **Take care to discharge properly before touching the inside of the device!**

WARNING! Electric shock!



Upon opening the housing, live parts are exposed!

→ **Always disconnect the device from power supply before opening the housing!**

i Note

The mains connection must be carried out with the common ground of the building to which the pipework of the solar circuit is connected.

i Note

Connecting the device to the power supply must always be the last step of the installation!

i Note

The pump speed must be set to 100% when auxiliary relays or valves are connected.

The power supply of the device must be 100 ... 240 V~ (50 ... 60 Hz). Attach flexible cables to the housing with the enclosed strain relief and the corresponding screws. The controller is equipped with 2 semiconductor relays to which **loads** such as pumps, valves, etc. can be connected:

Relay 1

18 = Conductor R1

17 = Neutral conductor N

13 = Protective earth conductor ⊕

Relay 2

16 = Conductor R2

15 = Neutral conductor N

14 = Protective earth conductor ⊕

The **mains connection** is at the following terminals:

19 = Neutral conductor N

20 = Conductor L

12 = Protective earth conductor ⊕

Connect the **temperature sensors** (S1 to S4) to the corresponding terminals with either polarity:

1/2 = Sensor 1 (e. g. collector sensor 1)

3/4 = Sensor 2 (e. g. store sensor 1)

5/6 = Sensor 3 (e. g. store sensor top)

7/8 = Sensor 4 (e. g. return sensor)

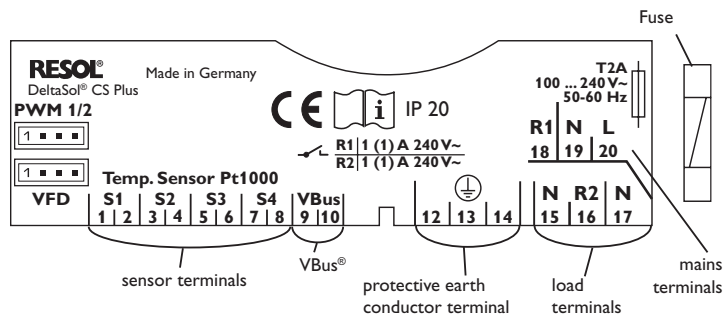

2.3 VFD Grundfos Direct Sensor™

The controller is equipped with 1 input for a digital VFD Grundfos Direct Sensor™ for measuring the flow rate and the temperature. Connection is made at the VFD terminal (bottom left).

2.4 PWM outputs

Speed control of a HE pump is possible via a PWM signal. The pump has to be connected to the relay as well as to one of the PWM outputs of the controller. Power is supplied to the HE pump by switching the corresponding relay on or off.

The terminals marked **PWM 1/2** are control outputs for pumps with PWM control input.

PWM 1/2 1 = PWM output 1, control signal

2 = PWM output 1, GND

3 = PWM output 2, GND

4 = PWM output 2, control signal



2.5 Data communication/Bus

The controller is equipped with the **RESOL VBus®** for data transfer and energy supply to external modules. The connection is to be carried out at the terminals marked **VBus** (either polarity).

One or more **RESOL VBus®** modules can be connected via this data bus, such as:

- RESOL DL2 Datalogger
- RESOL DL3 Datalogger

Furthermore, the controller can be connected to a PC or integrated into a network via the VBus®/USB or VBus®/LAN interface adapter (not included). Different solutions for visualisation and remote parameterisation are available on the RESOL website www.resol.com.



Note

More accessories on page 67.

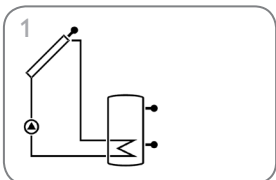

Standard solar system (page 8)

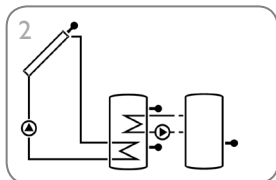

Solar system with heat exchange (page 11)

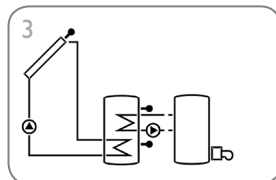

Solar system with backup heating (page 17)

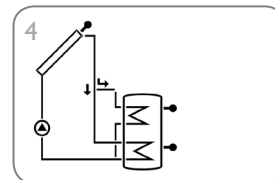

Solar system with store loading in layers (page 22)

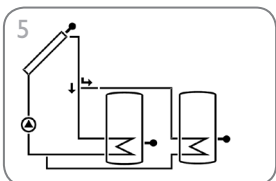

Solar system with 2 stores and valve logic (page 25)

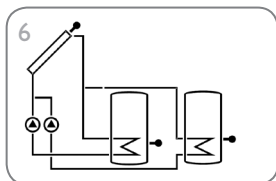

Solar system with 2 stores and pump logic (page 28)

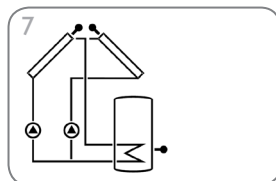

Solar system with east-/west collectors and 1 store (page 31)

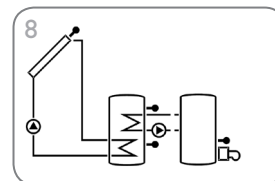

Solar system with backup heating by solid fuel boiler (page 34)

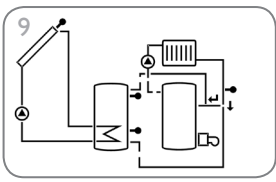

Solar system with heating circuit return preheating (page 40)

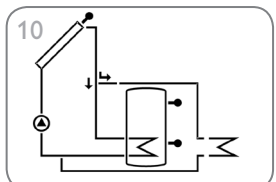

Standard solar system with heat dump (page 43)

2.7 Systems

Arrangement 1: Standard solar system

The controller calculates the temperature difference between collector sensor S1 and store sensor S2. If the difference is larger than or identical to the adjusted switch-on temperature difference (DT O), the solar pump will be activated by relay 1, and the store will be loaded until the switch-off temperature difference (DT F) or the maximum store temperature (SMX) is reached.

Sensors S3 and S4 can optionally be connected. S3 can optionally be used as the reference sensor for the store emergency shutdown option (OSEM). If heat quantity measurement (OHQM) is activated, S4 is used as the return sensor. If the drainback option (ODB) is activated, relay 2 can be used for activating a booster pump. For this purpose, the booster function (OBST) has to be activated.

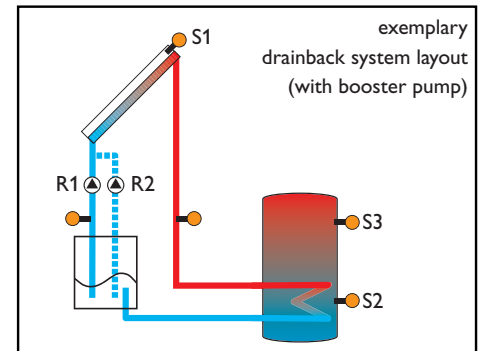
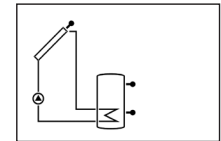
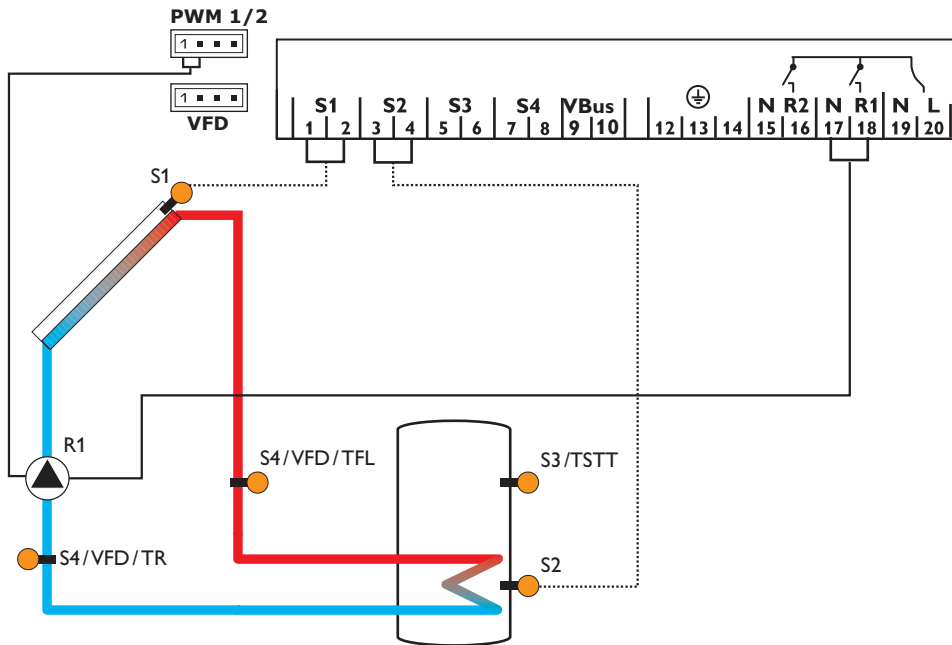

Display channels

Channel		Description	Connection terminal	Page
INIT	x*	ODB initialisation active	-	50
FLL	x*	ODB filling time active	-	50
STAB	x*	ODB stabilisation in progress	-	50
COL	x	Temperature collector	S1	51
TST	x	Temperature store	S2	51
S3	x	Temperature sensor 3	S3	51
TSTT	x*	Temperature store top	S3	51
S4	x	Temperature sensor 4	S4	51
TFL	x*	Temperature flow sensor	S1 / S4 / VFD	51
TR	x*	Temperature return sensor	S4 / VFD	51
VFD	x*	Temperature Grundfos Direct Sensor™	VFD	51
L/h	x*	Flow rate Grundfos Direct Sensor™	VFD	52
n%	x	Speed R1	R1	52
hP	x	Operating hours R1	R1	53
hP1	x*	Operating hours R1 (if OBST is activated)	R1	53
hP2	x*	Operating hours R2 (if OBST is activated)	R2	53
kWh	x*	Heat quantity in kWh	-	52
MWh	x*	Heat quantity in MWh	-	52
TIME	x	Time	-	53

Adjustment channels

Channel		Description	Factory setting	Page
Arr	x	System	1	53
DT O	x	Switch-on temperature difference R1	6.0 K [12.0 °Ra]	54
DT F	x	Switch-off temperature difference R1	4.0 K [8.0 °Ra]	54
DT S	x	Set temperature difference R1	10.0 K [20.0 °Ra]	54
RIS	x	Rise R1	2 K [4 °Ra]	54
PUM1	x	Pump control type R1	PSOL	54
nMN	x	Minimum speed R1	30%	55
nMX	x	Maximum speed R1	100%	55
S MX	x	Maximum store temperature	60 °C [140 °F]	55
OSEM	x	Store emergency shutdown option	OFF	55
EM	x	Collector emergency temperature	130 °C [270 °F]	56
		Collector emergency temperature if ODB is activated:	95 °C [200 °F]	56
OCC	x	Collector cooling option	OFF	56
CMX	x*	Maximum collector temperature	110 °C [230 °F]	56
OSYC	x	System cooling option	OFF	57

Adjustment channels

Channel		Description	Factory setting	Page
DTCO	x*	Switch-on temperature difference cooling	20.0 K [40.0 °Ra]	57
DTCF	x*	Switch-off temperature difference cooling	15.0 K [30.0 °Ra]	57
OSTC	x	Store cooling option	OFF	57
OHOL	x*	Holiday cooling option	OFF	57
THOL	x*	Holiday cooling temperature	40 °C [110 °F]	57
OCN	x	Collector minimum limitation option	OFF	58
CMN	x*	Collector minimum temperature	10 °C [50 °F]	58
OCF	x	Antifreeze option	OFF	58
CFR	x*	Antifreeze temperature	4.0 °C [40.0 °F]	58
OTC	x	Tube collector option	OFF	59
TCST	x*	OTC starting time	07:00	59
TCEN	x*	OTC ending time	19:00	60
TCRU	x*	OTC runtime	30 s	60
TCIN	x*	OTC standstill interval	30 min	60
GFD	x	Grundfos Direct Sensor™	OFF	60
OHQM	x	Heat quantity measurement option	OFF	60
SEN	x*	VFD allocation	2	61
FMAX	x*	Maximum flow rate	6.0 l/min	60
MEDT	x*	Antifreeze type	1	61
MED%	x*	Antifreeze concentration (only if MEDT = propylene or ethylene glycol)	45%	61
ODB	x	Drainback option	OFF	62
tDTO	x*	ODB switch-on condition - time period	60 s	62
tFLL	x*	ODB filling time	5.0 min	62
tSTB	x*	ODB stabilisation time	2.0 min	62
OBST	s*	Option booster function	OFF	62
MAN1	x	Manual mode R1	Auto	63
MAN2	x	Manual mode R2	Auto	63
LANG	x	Language	dE	63
UNIT	x	Temperature unit	°C	63
RESE	x	Reset - back to factory settings		63
#####		Version number		

Legend:

Symbol	Description
x	Channel is available
x*	Channel is available, if the corresponding option is activated.
s*	System-specific channel, only available if the corresponding option is activated

Arrangement 2: Solar system with heat exchange

The controller calculates the temperature difference between collector sensor S1 and store sensor S2. If the difference is larger than or identical to the adjusted switch-on temperature difference (DT O), the solar pump will be activated by relay 1, and the store will be loaded until the switch-off temperature difference (DT F) or the maximum store temperature (SMX) is reached.

Heat exchange from store 1 to store 2 will be operated by relay 2, if the temperature difference between sensors S3 and S4 is larger than or identical to the adjusted

switch-on temperature difference (DT3O), until the adjusted minimum (MN3O) and maximum (MX3O) temperature thresholds of the respective store are reached. S3 can optionally be used as the reference sensor for the store emergency shut-down option (OSEM).

If heat quantity measurement (OHQM) is activated, S1 and VFD are used as the flow and return sensors respectively.

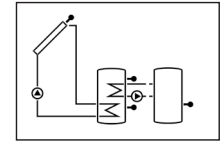
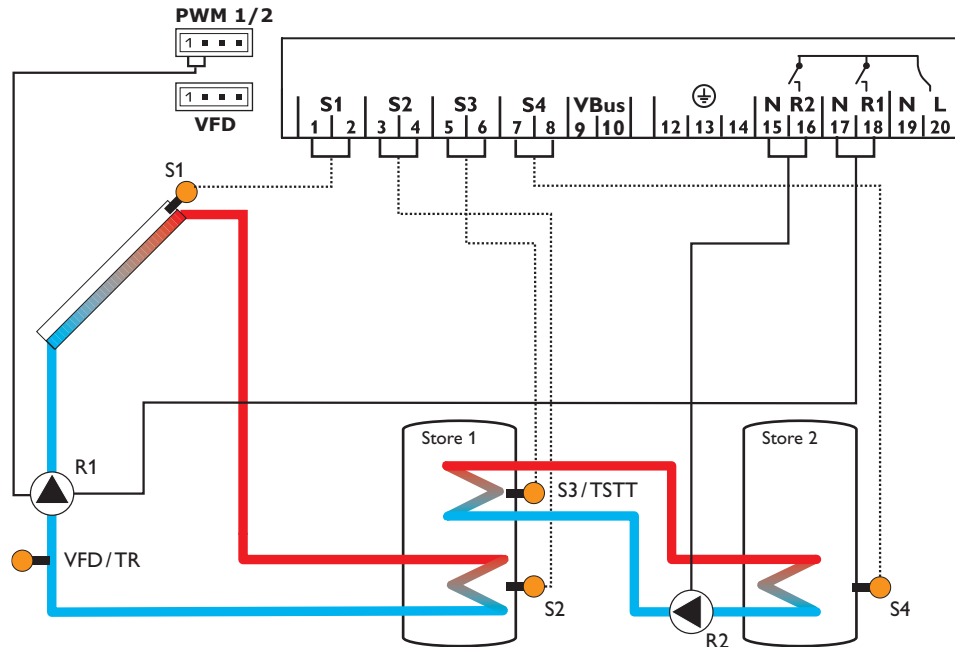

Display channels

Channel		Description	Connection terminal	Page
INIT	x*	ODB initialisation active	-	50
FLL	x*	ODB filling time active	-	50
STAB	x*	ODB stabilisation in progress	-	50
COL	x	Temperature collector	S1	51
TST1	x	Temperature store 1 base	S2	51
TSTT	x	Temperature store 1 top	S3	51
TST2	x	Temperature store 2 base	S4	51
TFL	x*	Temperature flow sensor	S1	51
TR	x*	Temperature return sensor	VFD	51
VFD	x*	Temperature Grundfos Direct Sensor™	VFD	51
L/h	x*	Flow rate Grundfos Direct Sensor™	VFD	52
n1%	x	Speed R1	R1	52
n2%	x	Speed R2	R2	52
h P1	x	Operating hours R1	R1	53
h P2	x	Operating hours R2	R2	53
kWh	x*	Heat quantity in kWh	-	52
MWh	x*	Heat quantity in MWh	-	52
TIME	x	Time	-	53

Adjustment channels

Channel		Description	Factory setting	Page
Arr	x	System	2	53
DT O	x	Switch-on temperature difference R1	6.0 K [12.0 °Ra]	54
DT F	x	Switch-off temperature difference R1	4.0 K [8.0 °Ra]	54
DT S	x	Set temperature difference R1	10.0 K [20.0 °Ra]	54
RIS	x	Rise R1	2 K [4 °Ra]	54
PUM1	x	Pump control type R1	PSOL	54
n1MN	x	Minimum speed R1	30%	55
n1MX	x	Maximum speed R1	100%	55
S MX	x	Maximum store temperature	60 °C [140 °F]	55
OSEM	x	Store emergency shutdown option	OFF	55
PUM2	x	Pump control type R2	OnOF	54
n2MN	x*	Minimum speed R2	30%	55
n2MX	x*	Maximum speed R2	100%	55
EM	x	Collector emergency temperature	130 °C [270 °F]	56
		Collector emergency temperature if ODB is activated:	95 °C [200 °F]	56
OCC	x	Collector cooling option	OFF	56
CMX	x*	Maximum collector temperature	110 °C [230 °F]	56
OSYC	x	System cooling option	OFF	57
DTCO	x*	Switch-on temperature difference cooling	20.0 K [40.0 °Ra]	57
DTCF	x*	Switch-off temperature difference cooling	15.0 K [30.0 °Ra]	57

Adjustment channels

Channel		Description	Factory setting	Page
OSTC	x	Store cooling option	OFF	57
OHOL	x*	Holiday cooling option	OFF	57
THOL	x*	Holiday cooling temperature	40 °C [110 °F]	57
OCN	x	Collector minimum limitation option	OFF	58
CMN	x*	Collector minimum temperature	10 °C [50 °F]	58
OCF	x	Antifreeze option	OFF	58
CFR	x*	Antifreeze temperature	4.0 °C [40.0 °F]	58
OTC	x	Tube collector option	OFF	59
TCST	x*	OTC starting time	07:00	59
TCEN	x*	OTC ending time	19:00	60
TCRU	x*	OTC runtime	30 s	60
TCIN	x*	OTC standstill interval	30 min	60
GFD	x	Grundfos Direct Sensor™	OFF	60
OHQM	x	Heat quantity measurement option	OFF	60
MEDT	x*	Antifreeze type	1	61
MED%	x*	Antifreeze concentration (only if MEDT = propylene or ethylene)	45 %	61
DT3O	s	Switch-on temperature difference R2	6.0 K [12.0 °Ra]	54
DT3F	s	Switch-off temperature difference R2	4.0 K [8.0 °Ra]	54
DT3S	s	Set temperature difference R2	10.0 K [20.0 °Ra]	54
RIS3	s	Rise R2	2 K [4 °Ra]	54
MX3O	s	Switch-on threshold for maximum temperature	60.0 °C [140.0 °F]	39
MX3F	s	Switch-off threshold for maximum temperature	58.0 °C [136.0 °F]	39
MN3O	s	Switch-on threshold for minimum temperature	5.0 °C [40.0 °F]	39
MN3F	s	Switch-off threshold for minimum temperature	10.0 °C [50.0 °F]	39
ODB	x	Drainback option	OFF	62
tDTO	x*	ODB switch-on condition - time period	60 s	62
tFLL	x*	ODB filling time	5.0 min	62
tSTB	x*	ODB stabilisation time	2.0 min	62
MAN1	x	Manual mode R1	Auto	63
MAN2	x	Manual mode R2	Auto	63
LANG	x	Language	dE	63
UNIT	x	Temperature unit	°C	63
RESE	x	Reset - back to factory settings		63
#####		Version number		

Legend:

Symbol	Description
x	Channel is available
x*	Channel is available, if the corresponding option is activated.
s	System-specific channel

System-specific functions

The following adjustments are used for the specific functions in system 2.

ΔT control for the heat exchange between 2 stores

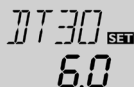

DT30 SET
6.0

DT30

Switch-on temperature difference
Adjustment range: 1.0 ... 20.0 K [2.0 ... 40.0 °Ra]
Factory setting: 6.0 K [12.0 °Ra]



DT3F SET
4.0

DT3F

Switch-off temperature difference
Adjustment range: 0.5 ... 19.5 K [1.0 ... 39.0 °Ra]
Factory setting: 4.0 K [8.0 °Ra]

S3 and S4 are used as the reference sensors for this function.

In system 2 the controller is equipped with an additional differential control for heat exchange between two stores. The basic differential function is adjusted using the switch-on (**DT30**) and switch-off (**DT3F**) temperature differences.

When the temperature difference exceeds the adjusted switch-on temperature difference, relay 2 switches on. When the temperature difference falls below the adjusted switch-off temperature difference, relay 2 switches off.



Note

The switch-on temperature difference must be at least 0.5 K [1 °Ra] higher than the switch-off temperature difference.

Speed control



DT3S SET
10.0 K

DT3S

Set temperature difference
Adjustment range: 1.5 ... 30.0 K [3.0 ... 60.0 °Ra]
Factory setting: 10.0 K [20.0 °Ra]



Note

For pump speed control of the heat exchange pump, the operating mode of relay 2 must be set to **Auto** in the adjustment channel **MAN2**.

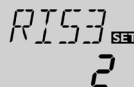

RIS3 SET
2

RIS3

Rise
Adjustment range: 1 ... 20 K [2 ... 40 °Ra]
Factory setting: 2 K [4 °Ra]

If the switch-on difference is reached, the pump switches on at full speed for 10 s. Then, the speed is reduced to the minimum pump speed value (**n2MN**).

If the temperature difference reaches the adjusted set value (**DT3S**), the pump speed increases by one step (10%). Each time the difference increases by the adjustable rise value **RIS3**, the pump speed increases by 10% until the maximum pump speed of 100% is reached.



Note

The set temperature difference must be at least 0.5 K [1 °Ra] higher than the switch-on temperature difference.



PUM2

Pump control type R2

Selection: OnOF, PULS, PSOL, PHEA

Factory setting: OnOF

With this parameter, the pump control type can be adjusted. The following types can be selected:

Adjustment for standard pump without speed control

- OnOF (pump on/pump off)

Adjustment for standard pump with speed control

- PULS (burst control via semiconductor relay)

Adjustment for high-efficiency pump (HE pump)

- PSOL (PWM profile for a HE solar pump)
- PHEA (PWM profile for a HE heating pump)



n2MN

Minimum speed R2

Adjustment range: (10) 30... 100%

Factory setting: 30%

A relative minimum pump speed can be allocated to the output R2 via the adjustment channel **n2MN**.



Note

The pump speed must be set to 100% when auxiliary relays or valves are connected.



n2MX

Maximum speed R2

Adjustment range: (10) 30... 100%

Factory setting: 100%

In the adjustment channel **n2MX** a relative maximum speed for a pump connected can be allocated to the output R2.



Note

The pump speed must be set to 100% when auxiliary relays or valves are connected.

Maximum temperature limitation heat exchange



MX30 SET
60.0



MX3F SET
58.0

MX30/MX3F

Maximum temperature limitation

Adjustment range: 0.0 ... 95.0 °C [30.0 ... 200.0 °F]

Factory setting:

MX30: 60.0 °C [140.0 °F]

MX3F: 58.0 °C [136.0 °F]

S4 is used as the reference sensor for the maximum temperature limitation.

The maximum temperature limitation function provides a maximum temperature setting, usually to reduce scald risk in a store. If **MX30** is exceeded, relay 2 is switched off until the temperature at sensor 4 falls below **MX3F**.

Minimum temperature limitation heat exchange



MN30 SET
5.0



MN3F SET
10.0

MN30/MN3F

Minimum temperature limitation

Adjustment range: 0.0 ... 90.0 °C [30.0 ... 190.0 °F]

Factory setting (only if Arr = 2):

MN30: 5.0 °C [40.0 °F]

MN3F: 10.0 °C [50.0 °F]

S3 is used as the reference sensor for the minimum temperature limitation.

The minimum temperature limitation function provides a minimum temperature setting for the heat source in system 2. If the temperature at sensor 3 falls below **MN30**, relay 2 is switched off until the temperature at sensor 3 exceeds **MN3F**.

Both switch-on and switch-off temperature differences **DT30** and **DT3F** are valid for the maximum and minimum temperature limitation.

Arrangement 3: Solar system with backup heating

The controller calculates the temperature difference between collector sensor S1 and store sensor S2. If the difference is larger than or identical to the adjusted switch-on temperature difference (DT O), the solar pump will be activated by relay 1, and the store will be loaded until the switch-off temperature difference (DT F) or the maximum store temperature (SMX) is reached.

Sensor S3 is used for a thermostat function, which operates relay 2 for backup heating or heat dump purposes, when the adjusted thermostat switch-on tempera-

ture (AH O) is reached. This function can optionally be combined with up to three adjustable time frames.

Sensor S3 can optionally be used as the reference sensor for the thermal disinfection function (OTD) or the store emergency shutdown option (OSEM).

Sensor S4 can optionally be connected. If heat quantity measurement (OHQM) is activated, S4 and VFD are used as the flow and return sensors respectively.

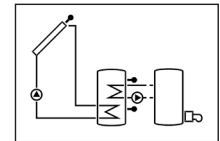
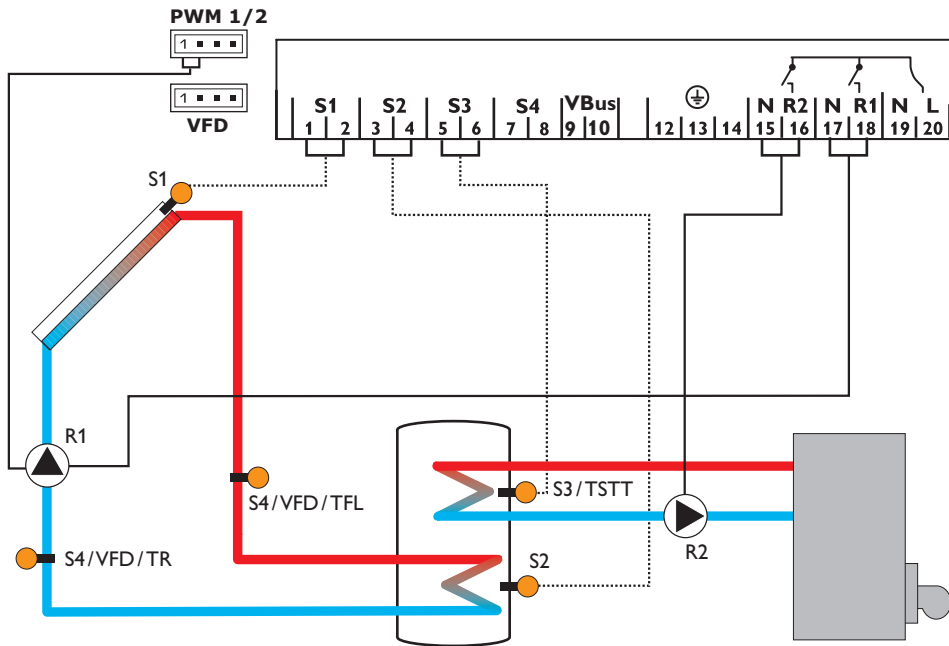

Display channels

Channel		Description	Connection terminal	Page
INIT	x*	ODB initialisation active	-	50
FLL	x*	ODB filling time active	-	50
STAB	x*	ODB stabilisation in progress	-	50
COL	x	Temperature collector	S1	51
TSTB	x	Temperature store 1 base	S2	51
TSTT	x	Temperature store 1 top	S3	51
TDIS	s*	Thermal disinfection temperature (thermal disinfection)	S3	51
S4	x	Temperature sensor 4	S4	51
TFL	x*	Temperature flow sensor	S1/S4/VFD	51
TR	x*	Temperature return sensor	S4/VFD	51
VFD	x*	Temperature Grundfos Direct Sensor™	VFD	51
L/h	x*	Flow rate Grundfos Direct Sensor™	VFD	52
n1%	x	Speed R1	R1	52
h P1	x	Operating hours R1	R1	53
h P2	x	Operating hours R2	R2	53
kWh	x*	Heat quantity in kWh	-	52
MWh	x*	Heat quantity in MWh	-	52
CDIS	s*	Countdown of monitoring period (thermal disinfection)	-	52
SDIS	s*	Starting time display (thermal disinfection)	-	52
DDIS	s*	Heating period display (thermal disinfection)	-	52
TIME	x	Time	-	53

Adjustment channels

Channel		Description	Factory setting	Page
Arr	x	System	3	53
DT O	x	Switch-on temperature difference R1	6.0 K [12.0 °Ra]	54
DT F	x	Switch-off temperature difference R1	4.0 K [8.0 °Ra]	54
DT S	x	Set temperature difference R1	10.0 K [20.0 °Ra]	54
RIS	x	Rise R1	2 K [4 °Ra]	54
PUM1	x	Pump control type R1	PSOL	54
n1MN	x	Minimum speed R1	30%	55
n1MX	x	Maximum speed R1	100%	55
S MX	x	Maximum store temperature	60 °C [140 °F]	55
OSEM	x	Store emergency shutdown option	OFF	55
EM	x	Collector emergency temperature	130 °C [270 °F]	56
		Collector emergency temperature if ODB is activated:	95 °C [200 °F]	56
OCC	x	Collector cooling option	OFF	56
CMX	x*	Maximum collector temperature	110 °C [230 °F]	56
OSYC	x	System cooling option	OFF	57
DTCO	x*	Switch-on temperature difference cooling	20.0 K [40.0 °Ra]	57
DTCF	x*	Switch-off temperature difference cooling	15.0 K [30.0 °Ra]	57
OSTC	x	Store cooling option	OFF	57
OHOL	x*	Holiday cooling option	OFF	57
THOL	x*	Holiday cooling temperature	40 °C [110 °F]	57

Adjustment channels

Channel		Description	Factory setting	Page
OCN	x	Collector minimum limitation option	OFF	58
CMN	x*	Collector minimum temperature	10 °C [50 °F]	58
OCF	x	Antifreeze option	OFF	58
CFR	x*	Antifreeze temperature	4.0 °C [40.0 °F]	58
OTC	x	Tube collector option	OFF	59
TCST	x*	OTC starting time	07:00	59
TCEN	x*	OTC ending time	19:00	60
TCRU	x*	OTC runtime	30 s	60
TCIN	x*	OTC standstill interval	30 min	60
GFD	x	Grundfos Direct Sensor™	OFF	60
OHQM	x	Heat quantity measurement option	OFF	60
SEN	x*	VFD allocation	2	61
FMAX	x*	Maximum flow rate	6.0 l/min	60
MEDT	x*	Antifreeze type	1	61
MED%	x*	Antifreeze concentration	45 %	61
AH O	s	Switch-on temperature for thermostat	40 °C [110 °F]	20
AH F	s	Switch-off temperature for thermostat	45 °C [120 °F]	20
t1 O	s	Thermostat switch-on time 1	00:00	20
t1 F	s	Thermostat switch-off time 1	00:00	20
t2 O	s	Thermostat switch-on time 2	00:00	20
t2 F	s	Thermostat switch-off time 2	00:00	20
t3 O	s	Thermostat switch-on time 3	00:00	20
t3 F	s	Thermostat switch-off time 3	00:00	20
ODB	x	Drainback option	OFF	62
tDTO	x*	ODB switch-on condition - time period	60 s	62
tFLL	x*	ODB filling time	5.0 min	62
tSTB	x*	ODB stabilisation time	2.0 min	62
OTD	s	Thermal disinfection option	OFF	21
PDIS	s*	Monitoring period	01:00	21
DDIS	s*	Heating period	01:00	21
TDIS	s*	Disinfection temperature	60 °C [140 °F]	21
SDIS	s*	Starting time	00:00	21
MAN1	x	Manual mode R1	Auto	63
MAN2	x	Manual mode R2	Auto	63
LANG	x	Language	dE	63
UNIT	x	Temperature unit	°C	63
RESE	x	Reset - back to factory settings		63
#####		Version number		

Legend:

Symbol	Description
x	Channel is available
x*	Channel is available, if the corresponding option is activated.
s	System-specific channel
s*	System-specific channel, only available if the corresponding option is activated

System-specific functions

The following adjustments are used for the specific functions in system 3. The channels described are not available in any other systems.

Thermostat function

Backup heating

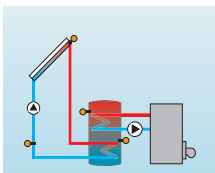

Use of surplus energy

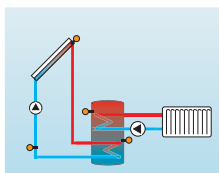

The thermostat function works independently from the solar operation and can be used for using surplus energy or for backup heating.

- **AH O < AH F**
thermostat function for backup heating
- **AH O > AH F**
thermostat function for using surplus energy

The symbol  will be shown on the display, if the second relay output is activated.

S3 is used as the reference sensor for the thermostat function.

A digital display showing "AH O" in the top line and "40.0" in the bottom line. A small "SET" indicator is visible to the right of the top line.

AH O

Thermostat switch-on temperature
Adjustment range: 0.0 ... 95.0 °C [30.0 ... 200.0 °F]
Factory setting: 40.0 °C [110.0 °F]

A digital display showing "AH F" in the top line and "45.0" in the bottom line. A small "SET" indicator is visible to the right of the top line.

AH F

Thermostat switch-off temperature
Adjustment range: 0.0 ... 95.0 °C [30.0 ... 200.0 °F]
Factory setting: 45.0 °C [120.0 °F]

A digital display showing "t1 O" in the top line and "00:00" in the bottom line. A small "SET" indicator is visible to the right of the top line.

t1 O, t2 O, t3 O

Thermostat switch-on time
Adjustment range: 00:00 ... 23:45
Factory setting: 00:00

A digital display showing "t1 F" in the top line and "00:00" in the bottom line. A small "SET" indicator is visible to the right of the top line.

t1 F, t2 F, t3 F

Thermostat switch-off time
Adjustment range: 00:00 ... 23:45
Factory setting: 00:00

In order to block the thermostat function for a certain period, there are 3 time frames t1 ... t3.

If the thermostat function is supposed to run from 06:00 a.m. to 09:00 a.m. only, adjust **t1 O** to 06:00 a.m. and **t1 F** to 09:00 a.m.

If the switch-on and switch-off times of a time frame are set to an identical value, the time frame will be inactive. If all time frames are set to 00:00, the thermostat function is solely temperature dependent (factory setting).

Thermal disinfection of the upper DHW zone



OTD

Therm. disinfection function
Adjustment range: OFF/ON
Factory setting: OFF

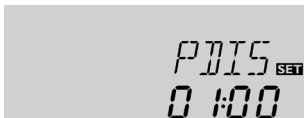

PDIS

Monitoring period
Adjustment range: 0 ... 30:0 ... 24 h (dd:hh)
Factory setting: 01:00

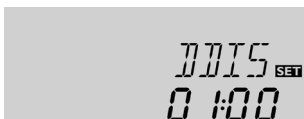

DDIS

Heating period
Adjustment range: 0:00 ... 23:59 (hh:mm)
Factory setting: 01:00

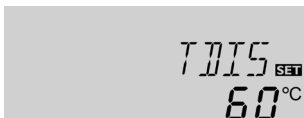

TDIS

Disinfection temperature
Adjustment range: 0 ... 95 °C [30 ... 200 °F]
Factory setting: 60 °C [140 °F]

This function helps to contain the spread of Legionella in DHW stores by systematically activating the backup heating.

For thermal disinfection, the temperature at the reference sensor will be monitored. Protection is ensured when, during the monitoring period, the disinfection temperature is continuously exceeded for the entire disinfection period.

The monitoring period starts as soon as the temperature at the reference sensor falls below the disinfection temperature. When the monitoring period ends, the allocated reference relay activates the backup heating. The disinfection period starts, if the temperature at the allocated sensor exceeds the disinfection temperature.

Thermal disinfection can only be completed when the disinfection temperature is exceeded for the duration of the disinfection period without any interruption.

Starting time delay

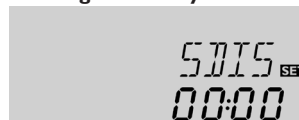

SDIS

Starting time
Adjustment range: 0:00 ... 24:00 (time)
Factory setting: 00:00

If the starting delay option is activated, a starting time for the thermal disinfection with starting delay can be adjusted. The activation of the backup heating is then delayed until that starting time after the monitoring period has ended.

If the monitoring period ends, for example, at 12:00 o'clock, and the starting time has been set to 18:00, the reference relay will be energised with a delay of 6 hours at 18:00 instead of 12:00 o'clock.



Note

If the thermal disinfection option is activated, the display channels **TDIS**, **CDIS**, **SDIS** and **DDIS** will be displayed.

Arrangement 4: Solar system with store loading in layers

The controller calculates the temperature difference between collector sensor S1 and store sensors S2 and S3. If the difference is larger than or identical to the corresponding adjusted switch-on temperature differences (DT1O/DT2O), the solar pump will be activated by relay 1, and the corresponding store zone will be loaded until the switch-off temperature difference (DT1F/DT2F) or the maximum store

temperature (S1MX/S2MX) is reached. The priority logic causes priority loading of the upper store zone, if possible. In that case, the 3-port valve will be operated by relay 2.

If heat quantity measurement (OHQM) is activated, S4 and VFD are used as the flow and return sensors respectively.

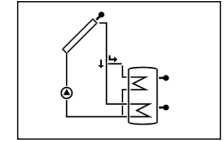
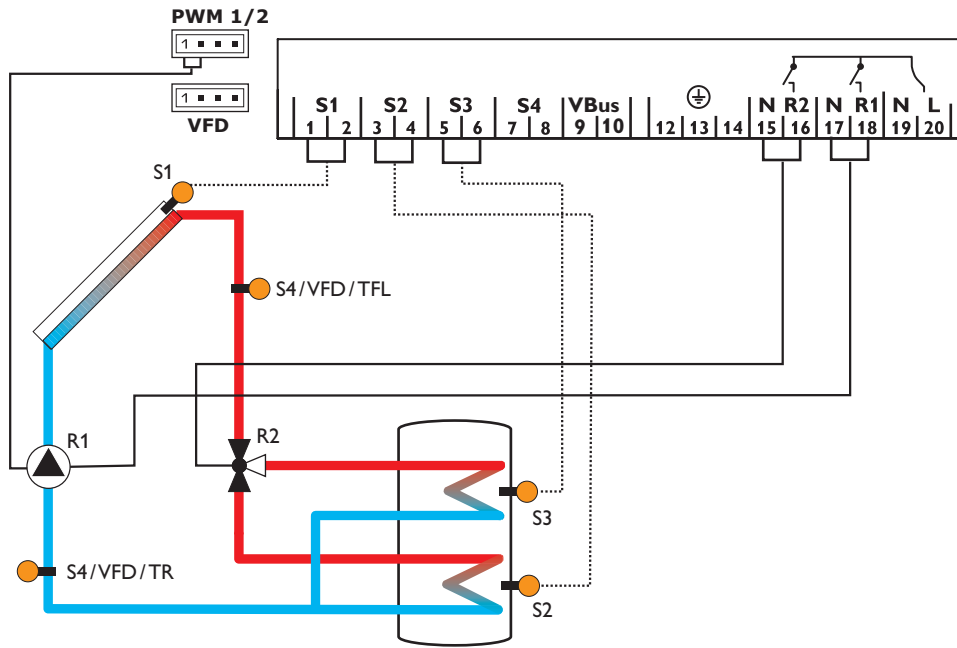

Display channels				
Channel		Description	Connection terminal	Page
COL	x	Temperature collector	S1	51
TSTB	x	Temperature store 1 base	S2	51
TSTT	x	Temperature store 1 top	S3	51
S4	x	Temperature sensor 4	S4	51
TFL	x*	Temperature flow sensor	S1/S4/VFD	51
TR	x*	Temperature return sensor	S4/VFD	51
VFD	x*	Temperature Grundfos Direct Sensor™	VFD	51
L/h	x*	Flow rate Grundfos Direct Sensor™	VFD	52
n%	x	Speed relay	R1	52
hP1	x	Operating hours R1	R1	53
hP2	x	Operating hours R2	R2	53
kWh	x*	Heat quantity in kWh	-	52
MWh	x*	Heat quantity in MWh	-	52
TIME	x	Time	-	53

Adjustment channels				
Channel		Description	Factory setting	Page
Arr	x	System	4	53
PUM1	x	Pump control type R1	PSOL	54
nMN	x	Minimum speed R1	30%	55
nMX	x	Maximum speed R1	100%	55
DT1O	x	Switch-on temperature difference R1	6.0 K [12.0 °Ra]	54
DT1F	x	Switch-off temperature difference R1	4.0 K [8.0 °Ra]	54
DT1S	x	Set temperature difference R1	10.0 K [20.0 °Ra]	54
RIS1	x	Rise R1	2 K [4 °Ra]	54
S1MX	x	Maximum store temperature 1	60 °C [140 °F]	54
DT2O	x	Switch-on temperature difference R2	6.0 K [12.0 °Ra]	54
DT2F	x	Switch-off temperature difference R2	4.0 K [8.0 °Ra]	54
DT2S	x	Set temperature difference R2	10.0 K [20.0 °Ra]	54
RIS2	x	Rise R2	2 K [4 °Ra]	54
S2MX	x	Maximum store temperature 2	60 °C [140 °F]	54
EM	x	Collector emergency temperature	130 °C [270 °F]	54
OCC	x	Collector cooling option	OFF	56
CMX	x*	Maximum collector temperature	110 °C [230 °F]	56
OSYC	x	System cooling option	OFF	57
DTCO	x*	Switch-on temperature difference cooling	20.0 K [40.0 °Ra]	57
DTCF	x*	Switch-off temperature difference cooling	15.0 K [30.0 °Ra]	57

Adjustment channels

Channel		Description	Factory setting	Page
OSTC	x	Store cooling option	OFF	57
OHOL	x*	Holiday cooling option	OFF	57
THOL	x*	Holiday cooling temperature	40 °C [110 °F]	57
OCN	x	Collector minimum limitation option	OFF	58
CMN	x*	Collector minimum temperature	10 °C [50 °F]	58
OCF	x	Antifreeze option	OFF	58
CFR	x*	Antifreeze temperature	4.0 °C [40.0 °F]	58
PRIO	x	Priority	2	58
tLB	x	Loading break (store sequence control)	2 min	59
tRUN	x	Circulation runtime (store sequence control)	15 min	59
OTC	x	Tube collector option	OFF	59
TCST	x*	OTC starting time	07:00	59
TCEN	x*	OTC ending time	19:00	60
TCRU	x*	OTC runtime	30 s	60
TCIN	x*	OTC standstill interval	30 min	60
GFD	x	Grundfos Direct Sensor™	OFF	60
OHQM	x	Heat quantity measurement option	OFF	60
SEN	x*	VFD allocation	2	61
FMAX	x*	Maximum flow rate	6.0 l/min	60
MEDT	x*	Antifreeze type	1	61
MED%	x*	Antifreeze concentration (only if MEDT = propylene or ethylene glycol)	45%	61
MAN1	x	Manual mode R1	Auto	63
MAN2	x	Manual mode R2	Auto	63
LANG	x	Language	dE	63
UNIT	x	Temperature unit	°C	63
RESE	x	Reset - back to factory settings		63
#####		Version number		

Legend:

Symbol	Description
x	Channel is available
x*	Channel is available, if the corresponding option is activated.

Arrangement 5: Solar system with 2 stores and valve logic

The controller calculates the temperature difference between collector sensor S1 and store sensors S2 and S3. If the difference is larger than or identical to the corresponding adjusted switch-on temperature differences (DT1O/DT2O), the solar pump will be activated by relay 1, and the corresponding store will be loaded until the switch-off temperature difference (DT1F/DT2F) or the maximum store

temperature (S1MX/S2MX) is reached. The priority logic causes priority loading of store 1. If store 2 is being loaded, relay 2 switches the 3-port valve. If heat quantity measurement (OHQM) is activated, S4 and VFD are used as the flow and return sensors respectively.

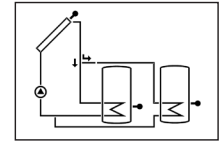
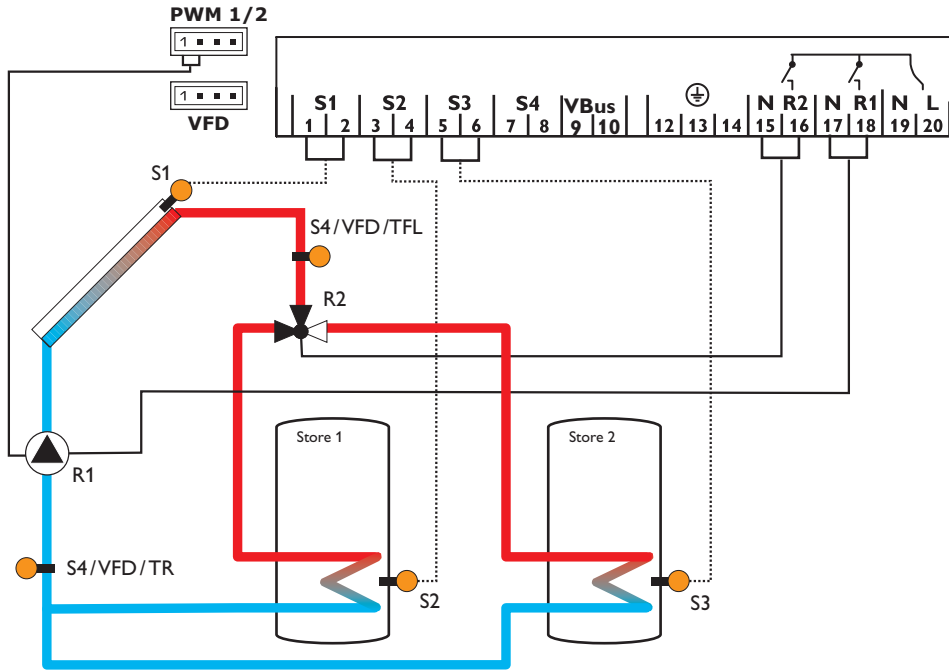

Display channels

Channel		Description	Connection terminal	Page
COL	x	Temperature collector	S1	51
TST1	x	Temperature store 1 base	S2	51
TST2	x	Temperature store 2 base	S3	51
S4	x	Temperature sensor 4	S4	51
TFL	x*	Temperature flow sensor	S1/S4/VFD	51
TR	x*	Temperature return sensor	S4/VFD	51
VFD	x*	Temperature Grundfos Direct Sensor™	VFD	51
L/h	x*	Flow rate Grundfos Direct Sensor™	VFD	52
n%	x	Speed relay R1	R1	52
hP1	x	Operating hours R1	R1	53
hP2	x	Operating hours R2	R2	53
kWh	x*	Heat quantity in kWh	-	52
MWh	x*	Heat quantity in MWh	-	52
TIME	x	Time	-	53

Adjustment channels

Channel		Description	Factory setting	Page
Arr	x	System	5	53
PUM1	x	Pump control type R1	PSOL	54
nMN	x	Minimum speed R1	30%	55
nMX	x	Maximum speed R1	100%	55
DT1O	x	Switch-on temperature difference R1	6.0 K [12.0 °Ra]	54
DT1F	x	Switch-off temperature difference R1	4.0 K [8.0 °Ra]	54
DT1S	x	Set temperature difference R1	10.0 K [20.0 °Ra]	54
RIS1	x	Rise R1	2 K [4 °Ra]	54
S1MX	x	Maximum store temperature 1	60 °C [140 °F]	54
DT2O	x	Switch-on temperature difference R2	6.0 K [12.0 °Ra]	54
DT2F	x	Switch-off temperature difference R2	4.0 K [8.0 °Ra]	54
DT2S	x	Set temperature difference R2	10.0 K [20.0 °Ra]	54
RIS2	x	Rise R2	2 K [4 °Ra]	54
S2MX	x	Maximum store temperature 2	60 °C [140 °F]	54
EM	x	Collector emergency temperature	130 °C [270 °F]	54
OCC	x	Collector cooling option	OFF	56
CMX	x*	Maximum collector temperature	110 °C [230 °F]	56
OSYC	x	System cooling option	OFF	57
DTCO	x*	Switch-on temperature difference cooling	20.0 K [40.0 °Ra]	57
DTCF	x*	Switch-off temperature difference cooling	15.0 K [30.0 °Ra]	57
OSTC	x	Store cooling option	OFF	57

Adjustment channels				
Channel		Description	Factory setting	Page
OHOL	x*	Holiday cooling option	OFF	57
THOL	x*	Holiday cooling temperature	40 °C [110 °F]	57
OCN	x	Collector minimum limitation option	OFF	58
CMN	x*	Collector minimum temperature	10 °C [50 °F]	58
OCF	x	Antifreeze option	OFF	58
CFR	x*	Antifreeze temperature	4.0 °C [40.0 °F]	58
PRIO	x	Priority	1	58
tLB	x	Loading break (store sequence control)	2 min	59
tRUN	x	Circulation runtime (store sequence control)	15 min	59
OTC	x	Tube collector option	OFF	59
TCST	x*	OTC starting time	07:00	59
TCEN	x*	OTC ending time	19:00	60
TCRU	x*	OTC runtime	30 s	60
TCIN	x*	OTC standstill interval	30 min	60
GFD	x	Grundfos Direct Sensor™	OFF	60
OHQM	x	Heat quantity measurement option	OFF	60
SEN	x*	VFD allocation	2	61
FMAX	x*	Maximum flow rate	6.0 l/min	60
MEDT	x*	Antifreeze type	1	61
MED%	x*	Antifreeze concentration (only if MEDT = propylene or ethylene glycol)	45 %	61
MAN1	x	Manual mode R1	Auto	63
MAN2	x	Manual mode R2	Auto	63
LANG	x	Language	dE	63
UNIT	x	Temperature unit	°C	63
RESE	x	Reset - back to factory settings		63
#####		Version number		

Legend:

Symbol	Description
x	Channel is available
x*	Channel is available, if the corresponding option is activated.

Arrangement 6: Solar system with 2 stores and pump logic

The controller calculates the temperature difference between collector sensor S1 and store sensors S2 and S3. If the difference is larger than or identical to the corresponding adjusted switch-on temperature differences (DT1O/DT2O), one or both solar pumps will be activated by relay 1 and/or relay 2, and the corresponding store will be loaded until the switch-off temperature difference (DT1F/DT2F) or the maximum store temperature (S1MX/S2MX) is reached. The priority logic causes

priority loading of the store selected in the PRIO channel, if possible. If PRIO = 0, both stores will be loaded simultaneously.

Sensor S4 can optionally be used as the reference sensor for the store emergency shutdown option (OSEM). If heat quantity measurement (OHQM) is activated, S4 and VFD are used as the flow and return sensors respectively.

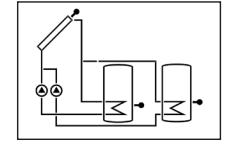
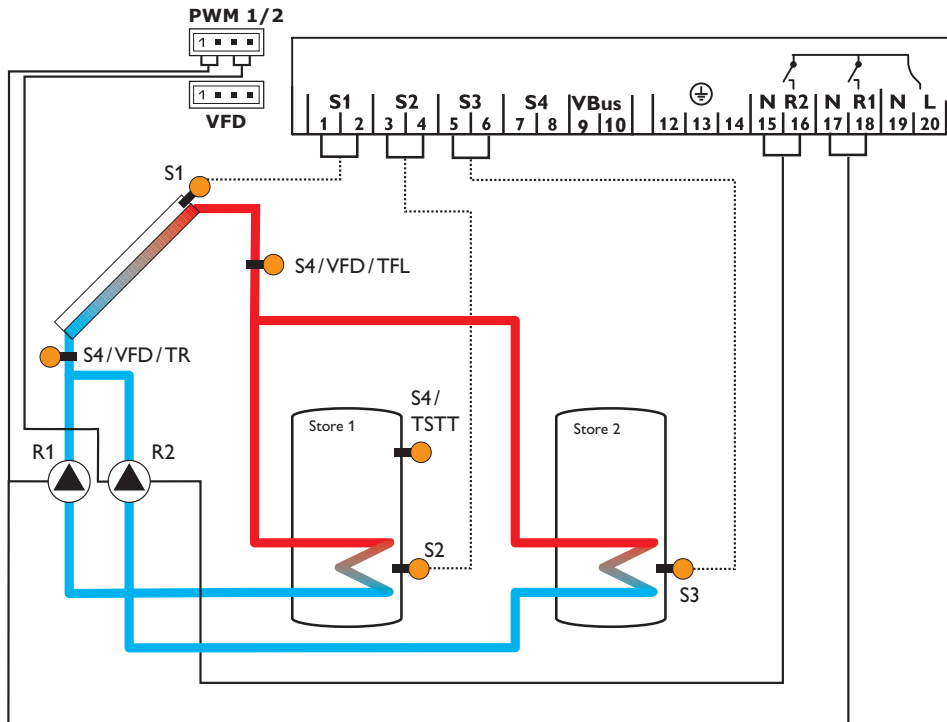

Display channels				
Channel		Description	Connection terminal	Page
COL	x	Temperature collector	S1	51
TST1	x	Temperature store 1 base	S2	51
TST2	x	Temperature store 2 base	S3	51
S4	x	Temperature sensor 4	S4	51
TSTT	x*	Temperature store top	S4	51
TFL	x*	Temperature flow sensor	S4/VFD	51
TR	x*	Temperature return sensor	S4/VFD	51
VFD	x*	Temperature Grundfos Direct Sensor™	VFD	51
L/h	x*	Flow rate Grundfos Direct Sensor™	VFD	52
n1%	x	Speed R1	R1	52
n2%	x	Speed R2	R2	52
h P1	x	Operating hours R1	R1	53
h P2	x	Operating hours R2	R2	53
kWh	x*	Heat quantity in kWh	-	52
MWh	x*	Heat quantity in MWh	-	52
TIME	x	Time	-	53

Adjustment channels				
Channel		Description	Factory setting	Page
Arr	x	System	6	53
DT1O	x	Switch-on temperature difference R1	6.0 K [12.0 °Ra]	54
DT1F	x	Switch-off temperature difference R1	4.0 K [8.0 °Ra]	54
DT1S	x	Set temperature difference R1	10.0 K [20.0 °Ra]	54
RIS1	x	Rise R1	2 K [4 °Ra]	54
PUM1	x	Pump control type R1	PSOL	54
n1MN	x	Minimum speed R1	30%	55
n1MX	x	Maximum speed R1	100%	55
S1MX	x	Maximum store temperature 1	60 °C [140 °F]	54
OSEM	x	Store emergency shutdown option	OFF	54
DT2O	x	Switch-on temperature difference R2	6.0 K [12.0 °Ra]	54
DT2F	x	Switch-off temperature difference R2	4.0 K [8.0 °Ra]	54
DT2S	x	Set temperature difference R2	10.0 K [20.0 °Ra]	54
RIS2	x	Rise R2	2 K [4 °Ra]	54
PUM2	x	Pump control type R2	PSOL	54
n2MN	x	Minimum speed R2	30%	55
n2MX	x	Maximum speed R2	100%	55
S2MX	x	Maximum store temperature 2	60 °C [140 °F]	54

Adjustment channels

Channel		Description	Factory setting	Page
EM	x	Collector emergency temperature	130 °C [270 °F]	54
OCC	x	Collector cooling option	OFF	56
CMX	x*	Maximum collector temperature	110 °C [230 °F]	56
OSYC	x	System cooling option	OFF	57
DTCO	x*	Switch-on temperature difference cooling	20.0 K [40.0 °Ra]	57
DTCF	x*	Switch-off temperature difference cooling	15.0 K [30.0 °Ra]	57
OSTC	x	Store cooling option	OFF	57
OHOL	x*	Holiday cooling option	OFF	57
THOL	x*	Holiday cooling temperature	40 °C [110 °F]	57
OCN	x	Collector minimum limitation option	OFF	58
CMN	x*	Collector minimum temperature	10 °C [50 °F]	58
OCF	x	Antifreeze option	OFF	58
CFR	x*	Antifreeze temperature	4.0 °C [40.0 °F]	58
PRIO	x	Priority	1	58
tLB	x	Loading break (store sequence control)	2 min	59
tRUN	x	Circulation runtime (store sequence control)	15 min	59
DTSE	x*	Temperature difference spreaded loading	40 K [70 °Ra]	59
OTC	x	Tube collector option	OFF	59
TCST	x*	OTC starting time	07:00	59
TCEN	x*	OTC ending time	19:00	60
TCRU	x*	OTC runtime	30 s	60
TCIN	x*	OTC standstill interval	30 min	60
GFD	x	Grundfos Direct Sensor™	OFF	60
OHQM	x	Heat quantity measurement option	OFF	60
SEN	x*	VFD allocation	2	61
MEDT	x*	Antifreeze type	1	61
MED%	x*	Antifreeze concentration (only if MEDT = propylene or ethylene)	45%	61
MAN1	x	Manual mode R1	Auto	63
MAN2	x	Manual mode R2	Auto	63
LANG	x	Language	dE	63
UNIT	x	Temperature unit	°C	63
RESE	x	Reset - back to factory settings		63
#####		Version number		

Legend:

Symbol	Description
x	Channel is available
x*	Channel is available, if the corresponding option is activated.

Arrangement 7: Solar system with east-/west collectors and 1 store

The controller calculates the temperature difference between collector sensors S1 and S3 and store sensor S2. If the differences are larger than or identical to the adjusted switch-on temperature difference (DT O), one or both solar pumps will be activated by relay 1 and/or relay 2, and the store will be loaded until the switch-off temperature difference (DT F) or the maximum store temperature (SMX) is reached.

Sensor S4 can optionally be used as the reference sensor for the store emergency shutdown option (OSEM). If heat quantity measurement (OHQM) is activated, S4 and VFD are used as the flow and return sensors respectively.

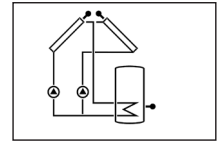
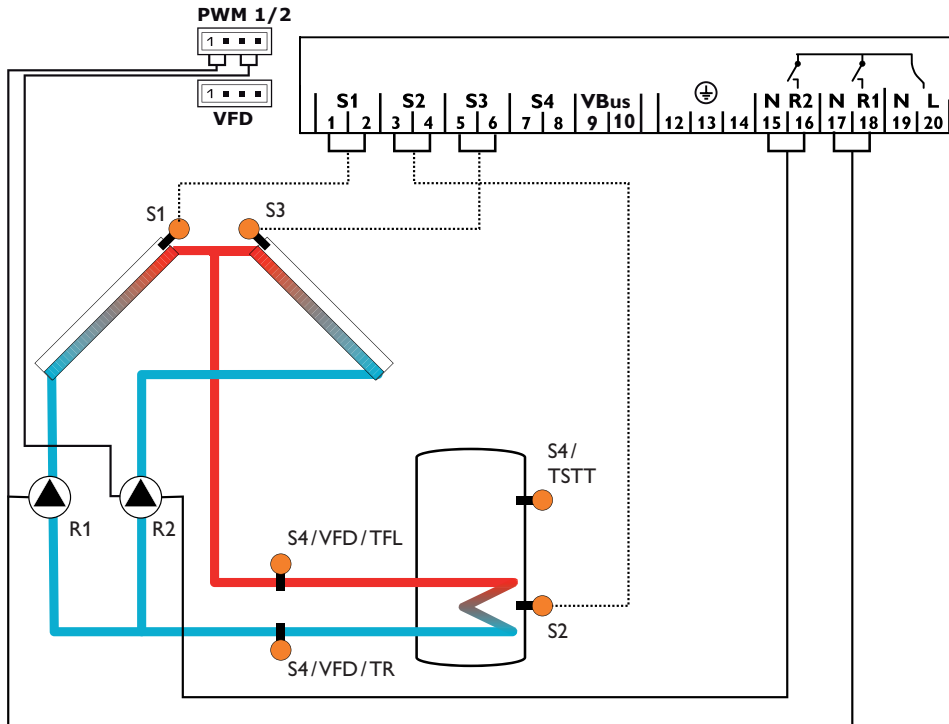

Display channels

Channel		Description	Connection terminal	Page
COL1	x	Temperature collector 1	S1	51
TST	x	Temperature store	S2	51
COL2	x	Temperature collector 2	S3	51
S4	x	Temperature sensor 4	S4	51
TSTT	x*	Temperature store top	S4	51
TFL	x*	Temperature flow sensor	S4/VFD	51
TR	x*	Temperature return sensor	S4/VFD	51
VFD	x*	Temperature Grundfos Direct Sensor™	VFD	51
L/h	x*	Flow rate Grundfos Direct Sensor™	VFD	52
n1%	x	Speed R1	R1	52
n2%	x	Speed R2	R2	52
h P1	x	Operating hours R1	R1	53
h P2	x	Operating hours R2	R2	53
kWh	x*	Heat quantity in kWh	-	52
MWh	x*	Heat quantity in MWh	-	52
TIME	x	Time	-	53

Adjustment channels

Channel		Description	Factory setting	Page
Arr	x	System	7	53
DT O	x	Switch-on temperature difference R1/R2	6.0 K [12.0 °Ra]	54
DT F	x	Switch-off temperature difference R1/R2	4.0 K [8.0 °Ra]	54
DT S	x	Set temperature difference R1/R2	10.0 K [20.0 °Ra]	54
RIS	x	Rise R1/R2	2 K [4 °Ra]	54
PUM1	x	Pump control type R1	PSOL	54
n1MN	x	Minimum speed R1	30%	55
n1MX	x	Maximum speed R1	100%	55
S MX	x	Maximum store temperature	60 °C [140 °F]	54
OSEM	x	Store emergency shutdown option	OFF	54
PUM2	x	Pump control type R2	PSOL	54
n2MN	x	Minimum speed R2	30%	55
n2MX	x	Maximum speed R2	100%	55
EM1	x	Collector emergency temperature 1	130 °C [270 °F]	54
EM2	x	Collector emergency temperature 2	130 °C [270 °F]	54
OCC1	x	Collector cooling option collector 1	OFF	56
CMX1	x*	Maximum collector temperature 1	110 °C [230 °F]	56
OCC2	x	Collector cooling option collector 2	OFF	56

Adjustment channels				
Channel		Description	Factory setting	Page
CMX2	x*	Maximum collector temperature 2	110 °C [230 °F]	56
OSYC	x	System cooling option	OFF	57
DTCO	x*	Switch-on temperature difference cooling	20.0 K [40.0 °Ra]	57
DTCF	x*	Switch-off temperature difference cooling	15.0 K [30.0 °Ra]	57
OSTC	x	Store cooling option	OFF	57
OHOL	x*	Holiday cooling option	OFF	57
THOL	x*	Holiday cooling temperature	40 °C [110 °F]	57
OCN1	x	Collector minimum limitation collector 1	OFF	58
CMN1	x*	Minimum collector temperature 1	10 °C [50 °F]	58
OCN2	x	Collector minimum limitation collector 2	OFF	58
CMN2	x*	Minimum collector temperature 2	10 °C [50 °F]	58
OCF1	x	Antifreeze option collector 1	OFF	58
CFR1	x*	Antifreeze temperature collector 1	4.0 °C [40.0 °F]	58
OCF2	x	Antifreeze option collector 2	OFF	58
CFR2	x*	Antifreeze temperature collector 2	4.0 °C [40.0 °F]	58
OTC	x	Tube collector option	OFF	59
TCST	x*	OTC starting time	07:00	59
TCEN	x*	OTC ending time	19:00	60
TCRU	x*	OTC runtime	30 s	60
TCIN	x*	OTC standstill interval	30 min	60
GFD	x	Grundfos Direct Sensor™	OFF	60
OHQM	x	Heat quantity measurement option	OFF	60
SEN	x*	VFD allocation	2	61
MEDT	x*	Antifreeze type	1	61
MED%	x*	Antifreeze concentration (only if MEDT = propylene or ethylene)	45 %	61
MAN1	x	Manual mode R1	Auto	63
MAN2	x	Manual mode R2	Auto	63
LANG	x	Language	dE	63
UNIT	x	Temperature unit	°C	63
RESE	x	Reset - back to factory settings		63
#####		Version number		

Legend:

Symbol	Description
x	Channel is available
x*	Channel is available, if the corresponding option is activated.

Arrangement 8: Solar system with backup heating by solid fuel boiler

The controller calculates the temperature difference between collector sensor S1 and store sensor S2. If the difference is larger than or identical to the adjusted switch-on temperature difference (DT O), the solar pump will be activated by relay 1, and the store will be loaded until the switch-off temperature difference (DT F) or the maximum store temperature (SMX) is reached.

A solid fuel boiler will be controlled by relay 2, if the temperature difference between sensors S4 and S3 is larger than or identical to the adjusted switch-on tem-

perature difference (DT3O), until the adjusted minimum (MN3O) and maximum (MX3O) temperature thresholds of the solid fuel boiler and the store are reached. S3 can optionally be used as the reference sensor for the store emergency shutdown option (OSEM).

If heat quantity measurement (OHQM) is activated, S4 and VFD are used as the flow and return sensors respectively.

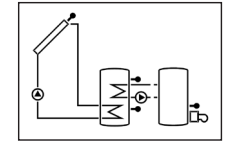
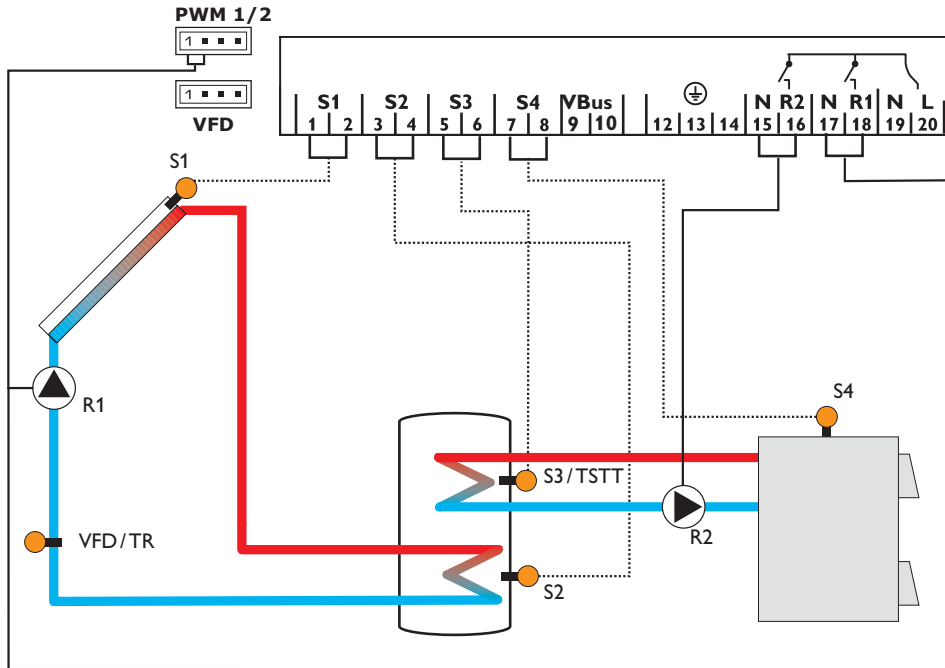

Display channels

Channel		Description	Connection terminal	Page
INIT	x*	ODB initialisation active	-	50
FLL	x*	ODB filling time active	-	50
STAB	x*	ODB stabilisation in progress	-	50
COL	x	Temperature collector	S1	51
TSTB	x	Temperature store 1 base	S2	51
TSTT	x	Temperature store 1 top	S3	51
TSFB	x	Temperature solid fuel boiler	S4	51
TFL	x*	Temperature flow sensor	S1	51
TR	x*	Temperature return sensor	VFD	51
VFD	x*	Temperature Grundfos Direct Sensor™	VFD	51
L/h	x*	Flow rate Grundfos Direct Sensor™	VFD	52
n1 %	x	Speed R1	R1	52
n2 %	x	Speed R2	R2	52
h P1	x	Operating hours R1	R1	53
h P2	x	Operating hours R2	R2	53
kWh	x*	Heat quantity in kWh	-	52
MWh	x*	Heat quantity in MWh	-	52
TIME	x	Time	-	53

Adjustment channels

Channel		Description	Factory setting	Page
Arr	x	System	8	53
DT O	x	Switch-on temperature difference R1	6.0 K [12.0 °Ra]	54
DT F	x	Switch-off temperature difference R1	4.0 K [8.0 °Ra]	54
DT S	x	Set temperature difference R1	10.0 K [20.0 °Ra]	54
RIS	x	Rise R1	2 K [4 °Ra]	54
PUM1	x	Pump control type R1	PSOL	54
n1MN	x	Minimum speed R1	30 %	55
n1MX	x	Maximum speed R1	100 %	55
S MX	x	Maximum store temperature	60 °C [140 °F]	54
OSEM	x	Store emergency shutdown option	OFF	54
PUM2	x	Pump control type R2	OnOF	54
n2MN	x*	Minimum speed R2	30 %	55
n2MX	x*	Maximum speed R2	100 %	55
EM	x	Collector emergency temperature	130 °C [270 °F]	54
		Collector emergency temperature if ODB is activated:	95 °C [200 °F]	54
OCC	x	Collector cooling option	OFF	56
CMX	x*	Maximum collector temperature	110 °C [230 °F]	56
OSYC	x	System cooling option	OFF	57
DTCO	x*	Switch-on temperature difference cooling	20.0 K [40.0 °Ra]	57
DTCF	x*	Switch-off temperature difference cooling	15.0 K [30.0 °Ra]	57

Adjustment channels

Channel		Description	Factory setting	Page
OSTC	x	Store cooling option	OFF	57
OHOL	x*	Holiday cooling option	OFF	57
THOL	x*	Holiday cooling temperature	40 °C [110 °F]	57
OCN	x	Collector minimum limitation option	OFF	58
CMN	x*	Collector minimum temperature	10 °C [50 °F]	58
OCF	x	Antifreeze option	OFF	58
CFR	x*	Antifreeze temperature	4.0 °C [40.0 °F]	58
OTC	x	Tube collector option	OFF	59
TCST	x*	OTC starting time	07:00	59
TCEN	x*	OTC ending time	19:00	60
TCRU	x*	OTC runtime	30 s	60
TCIN	x*	OTC standstill interval	30 min	60
GFD	x	Grundfos Direct Sensor™	OFF	60
OHQM	x	Heat quantity measurement option	OFF	60
SEN	x*	VFD allocation	2	61
MEDT	x*	Antifreeze type	1	61
MED%	x*	Antifreeze concentration (only if MEDT = propylene or ethylene)	45%	61
DT3O	s	Switch-on temperature difference R2	6.0 K [12.0 °Ra]	54
DT3F	s	Switch-off temperature difference R2	4.0 K [8.0 °Ra]	54
DT3S	s	Set temperature difference R2	10.0 K [20.0 °Ra]	54
RIS3	s	Rise R2	2 K [4 °Ra]	54
MX3O	s	Switch-on threshold for maximum temperature	60.0 °C [140.0 °F]	39
MX3F	s	Switch-off threshold for maximum temperature	58.0 °C [136.0 °F]	39
MN3O	s	Switch-on threshold for minimum temperature	60.0 °C [140.0 °F]	39
MN3F	s	Switch-off threshold for minimum temperature	65.0 °C [150.0 °F]	39
ODB	x	Drainback option	OFF	62
tDTO	x*	ODB switch-on condition - time period	60 s	62
tFLL	x*	ODB filling time	5.0 min	62
tSTB	x*	ODB stabilisation time	2.0 min	62
MAN1	x	Manual mode R1	Auto	63
MAN2	x	Manual mode R2	Auto	63
LANG	x	Language	dE	63
UNIT	x	Temperature unit	°C	63
RESE	x	Reset - back to factory settings		63
#####		Version number		

Legend:

Symbol	Description
x	Channel is available
x*	Channel is available, if the corresponding option is activated.
s	System-specific channel
s*	System-specific channel, only available if the corresponding option is activated

System-specific functions

The following adjustments are used for the specific functions in system 8.

ΔT control for the backup heating by a solid fuel boiler



DT30

Switch-on temperature difference

Adjustment range: 1.0 ... 20.0 K [2.0 ... 40.0 °Ra]

Factory setting: 6.0 K [12.0 °Ra]

S4 and S3 are used as the reference sensors for this function.

In system 8 the controller is equipped with an additional differential control for heat exchange from a solid fuel boiler (e. g. pellet stove). The basic differential function is adjusted using the switch-on (**DT30**) and switch-off (**DT3F**) temperature differences.

When the temperature difference exceeds the adjusted switch-on temperature difference, relay 2 switches on. When the temperature difference falls below the adjusted switch-off temperature difference, relay 2 switches off.



DT3F

Switch-off temperature difference

Adjustment range: 0.5 ... 19.5 K [1.0 ... 39.0 °Ra]

Factory setting: 4.0 K [8.0 °Ra]



Note

The switch-on temperature difference must be at least 0.5 K [1 °Ra] higher than the switch-off temperature difference.

Speed control

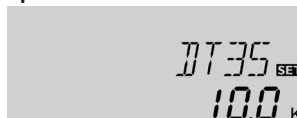

DT35

Set temperature difference

Adjustment range: 1.5 ... 30.0 K [3.0 ... 60.0 °Ra]

Factory setting: 10.0 K [20.0 °Ra]



Note

For pump speed control of the heat exchange pump, the operating mode of relay 2 must be set to **Auto** in the adjustment channel **MAN2**.



RIS3

Rise

Adjustment range: 1 ... 20 K [2 ... 40 °Ra]

Factory setting: 2 K [4 °Ra]



Note

The set temperature difference must be at least 0.5 K [1 °Ra] higher than the switch-on temperature difference.

If the switch-on difference is reached, the pump switches on at full speed for 10 s. Then, the speed is reduced to the minimum pump speed value (**n2MN**).

If the temperature difference reaches the adjusted set value (**DT3S**), the pump speed increases by one step (10%). Each time the difference increases by the adjustable rise value **RIS3**, the pump speed increases by 10% until the maximum pump speed of 100% is reached.



PUM2 SET
OnOF

PUM2

Pump control type R2

Selection: OnOF, PULS, PSOL, PHEA

Factory setting: OnOF

With this parameter, the pump control type can be adjusted. The following types can be selected:

Adjustment for standard pump without speed control

- OnOF (pump on / pump off)

Adjustment for standard pump with speed control

- PULS (burst control via semiconductor relay)

Adjustment for high-efficiency pump (HE pump)

- PSOL (PWM profile for a HE solar pump)
- PHEA (PWM profile for a HE heating pump)

Minimum speed

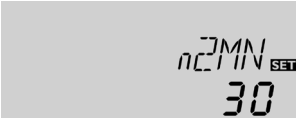

n2MN SET
30

n2MN

Minimum speed R2

Adjustment range: (10) 30 ... 100

Factory setting: 30

A relative minimum pump speed can be allocated to the output R2 via the adjustment channel **n2MN**.



Note

The pump speed must be set to 100% when auxiliary relays or valves are connected.

Maximum speed



n2MX SET
100

n2MX

Maximum speed R2

Adjustment range: (10) 30 ... 100%

Factory setting: 100%

In the adjustment channel **n2MX** a relative minimum speed for a pump connected can be allocated to the output R2.



Note

The pump speed must be set to 100% when auxiliary relays or valves are connected.

Maximum temperature limitation solid fuel boiler

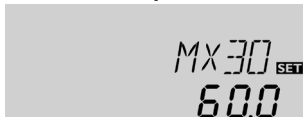

MX30 SET
60.0



MX3F SET
58.0

MX30/MX3F

Maximum temperature limitation

Adjustment range: 0.0 ... 95.0 °C [30.0 ... 200.0 °F]

Factory setting:

MX30: 60.0 °C [140.0 °F]

MX3F: 58.0 °C [136.0 °F]

S3 is used as the reference sensor for the maximum temperature limitation.

The maximum temperature limitation function provides a maximum temperature setting, usually to reduce scald risk in a store. If **MX30** is exceeded, relay 2 is switched off until the temperature at sensor 3 falls below **MX3F**.

Minimum temperature limitation solid fuel boiler



MN30 SET
60.0



MN3F SET
65.0

MN30/MN3F

Minimum temperature limitation

Adjustment range: 0.0 ... 90.0 °C [30.0 ... 190.0 °F]

Factory setting (only if Arr = 8):

MN30: 60.0 °C [140.0 °F]

MN3F: 65.0 °C [150.0 °F]

S4 is used as the reference sensor for the minimum temperature limitation.

The minimum temperature limitation function provides a minimum temperature setting for the solid fuel boiler in system 8. If the temperature at sensor 4 falls below **MN30**, relay 2 is switched off until the temperature at sensor 4 exceeds **MN3F**.

Both switch-on and switch-off temperature differences **DT30** and **DT3F** are valid for the maximum and minimum temperature limitation.

Arrangement 9: Solar system with heating-circuit return preheating

The controller calculates the temperature difference between collector sensor S1 and store sensor S2. If the difference is larger than or identical to the adjusted switch-on temperature difference (DT O), the solar pump will be activated by relay 1, and the store will be loaded until the switch-off temperature difference (DT F) or the maximum store temperature (SMX) is reached.

Heating-circuit return preheating will be activated by relay 2, if the temperature difference between sensors S3 and S4 is larger or identical to the adjusted switch-on temperature difference (DT3O). For this purpose, relay 2 controls the 3-port valve. S3 can optionally be used as the reference sensor for the store emergency shut-down option (OSEM). If heat quantity measurement (OHQM) is activated, S4 and VFD are used as the flow and return sensors respectively.

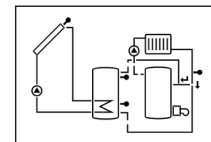
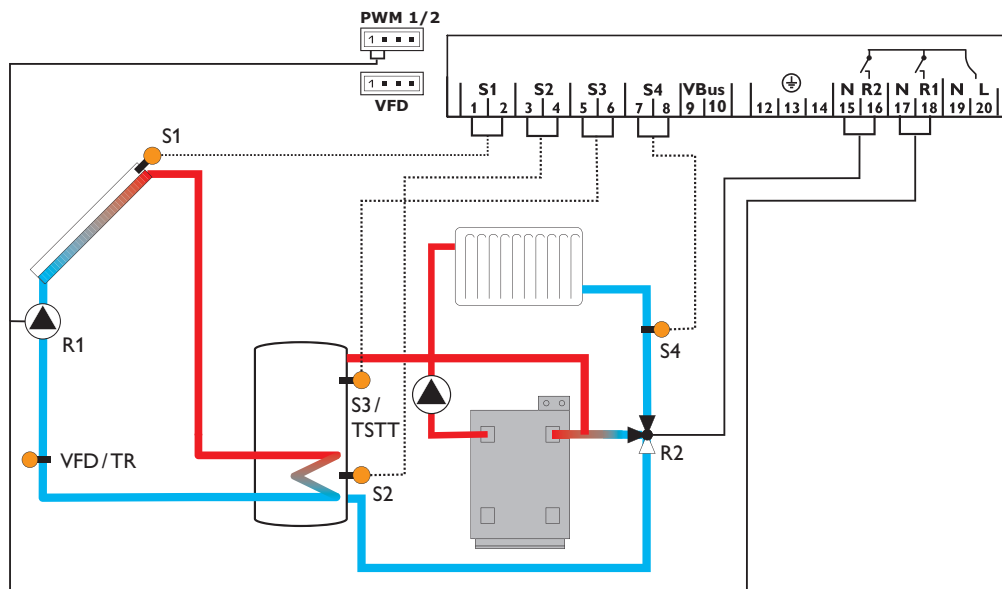

Display channels				
Channel		Description	Connection terminal	Page
INIT	x*	ODB initialisation active	-	50
FLL	x*	ODB filling time active	-	50
STAB	x*	ODB stabilisation in progress	-	50
COL	x	Temperature collector	S1	51
TSTB	x	Temperature store 1 base	S2	51
TSTT	x	Temperature store 1 top	S3	51
TFL	x*	Temperature flow sensor	S1	51
TR	x*	Temperature return sensor	VFD	51
VFD	x*	Temperature Grundfos Direct Sensor™	VFD	51
L/h	x*	Flow rate Grundfos Direct Sensor™	VFD	52
TRET	x	Temperature heating circuit	S4	51
n%	x	Speed relay R1	R1	52
hP1	x	Operating hours R1	R1	53
hP2	x	Operating hours R2	R2	53
kWh	x*	Heat quantity in kWh	-	52
MWh	x*	Heat quantity in MWh	-	52
TIME	x	Time	-	53

Adjustment channels				
Channel		Description	Factory setting	Page
Arr	x	System	9	53
DT O	x	Switch-on temperature difference R1	6.0 K [12.0 °Ra]	54
DT F	x	Switch-off temperature difference R1	4.0 K [8.0 °Ra]	54
DT S	x	Set temperature difference R1	10.0 K [20.0 °Ra]	54
RIS	x	Rise R1	2 K [4 °Ra]	54
PUM1	x	Pump control type R1	PSOL	54
nMN	x	Minimum speed R1	30%	55
nMX	x	Maximum speed R1	100%	55
S MX	x	Maximum store temperature	60 °C [140 °F]	54
OSEM	x	Store emergency shutdown option	OFF	54
EM	x	Collector emergency temperature	130 °C [270 °F]	54
		Collector emergency temperature if ODB is activated:	95 °C [200 °F]	54
OCC	x	Collector cooling option	OFF	56
CMX	x*	Maximum collector temperature	110 °C [230 °F]	56
OSYC	x	System cooling option	OFF	57
DTCO	x*	Switch-on temperature difference cooling	20.0 K [40.0 °Ra]	57
DTCF	x*	Switch-off temperature difference cooling	15.0 K [30.0 °Ra]	57

Adjustment channels				
Channel		Description	Factory setting	Page
OSTC	x	Store cooling option	OFF	57
OHOL	x*	Holiday cooling option	OFF	57
THOL	x*	Holiday cooling temperature	40 °C [110 °F]	57
OCN	x	Collector minimum limitation option	OFF	58
CMN	x*	Collector minimum temperature	10 °C [50 °F]	58
OCF	x	Antifreeze option	OFF	58
CFR	x*	Antifreeze temperature	4.0 °C [40.0 °F]	58
OTC	x	Tube collector option	OFF	59
TCST	x*	OTC starting time	07:00	59
TCEN	x*	OTC ending time	19:00	60
TCRU	x*	OTC runtime	30 s	60
TCIN	x*	OTC standstill interval	30 min	60
GFD	x	Grundfos Direct Sensor™	OFF	60
OHQM	x	Heat quantity measurement option	OFF	60
SEN	x*	VFD allocation	2	61
MEDT	x*	Antifreeze type	1	61
MED%	x*	Antifreeze concentration (only if MEDT = propylene or ethylene)	45%	61
DT3O	s	Switch-on temperature difference R2	6.0 K [12.0 °Ra]	54
DT3F	s	Switch-off temperature difference R2	4.0 K [8.0 °Ra]	54
ODB	x	Drainback option	OFF	62
tDТО	x*	ODB switch-on condition - time period	60 s	62
tFLL	x*	ODB filling time	5.0 min	62
tSTB	x*	ODB stabilisation time	2.0 min	62
MAN1	x	Manual mode R1	Auto	63
MAN2	x	Manual mode R2	Auto	63
LANG	x	Language	dE	63
UNIT	x	Temperature unit	°C	63
RESE	x	Reset - back to factory settings		63
#####		Version number		

Legend:

Symbol	Description
x	Channel is available
x*	Channel is available, if the corresponding option is activated.
s	System-specific channel
s*	System-specific channel, only available if the corresponding option is activated

Display channels				
Channel		Description	Connection terminal	Page
COL	x	Temperature collector	S1	51
TST	x	Temperature store	S2	51
S3	x	Temperature sensor 3	S3	51
TSTT	x*	Temperature store top	S3	51
S4	x	Temperature sensor 4	S4	51
TFL	x*	Temperature flow sensor	S1/S4/VFD	51
TR	x*	Temperature return sensor	S4/VFD	51
VFD	x*	Temperature Grundfos Direct Sensor™	VFD	51
L/h	x*	Flow rate Grundfos Direct Sensor™	VFD	52
n%	x	Speed relay R1	R1	52
h P1	x	Operating hours R1	R1	53
h P2	x	Operating hours R2	R2	53
kWh	x*	Heat quantity in kWh	-	52
MWh	x*	Heat quantity in MWh	-	52
TIME	x	Time	-	53

Adjustment channels				
Channel		Description	Factory setting	Page
Arr	x	System	10	53
DT O	x	Switch-on temperature difference R1	6.0 K [12.0 °Ra]	54
DT F	x	Switch-off temperature difference R1	4.0 K [8.0 °Ra]	54
DT S	x	Set temperature difference R1	10.0 K [20.0 °Ra]	54
RIS	x	Rise R1	2 K [4 °Ra]	54
PUM1	x	Pump control type R1	PSOL	54
nMN	x	Minimum speed R1	30%	55
nMX	x	Maximum speed R1	100%	55
S MX	x	Maximum store temperature	60 °C [140 °F]	54
OSEM	x	Store emergency shutdown option	OFF	54
EM	x	Collector emergency temperature	130 °C [270 °F]	54
CMX	s	Maximum collector temperature	110 °C [230 °F]	56
OCN	x	Collector minimum limitation option	OFF	58
CMN	x*	Collector minimum temperature	10 °C [50 °F]	58
OCF	x	Antifreeze option	OFF	58
CFR	x*	Antifreeze temperature	4.0 °C [40.0 °F]	58
OTC	x	Tube collector option	OFF	59
TCST	x*	OTC starting time	07:00	59
TCEN	x*	OTC ending time	19:00	60

Adjustment channels				
Channel		Description	Factory setting	Page
TCRU	x*	OTC runtime	30 s	60
TCIN	x*	OTC standstill interval	30 min	60
GFD	x	Grundfos Direct Sensor™	OFF	60
OHQM	x	Heat quantity measurement option	OFF	60
SEN	x*	VFD allocation	2	61
FMAX	x*	Maximum flow rate	6.0 l/min	60
MEDT	x*	Antifreeze type	1	61
MED%	x*	Antifreeze concentration (only if MEDT = propylene or ethylene glycol)	45 %	61
MAN1	x	Manual mode R1	Auto	63
MAN2	x	Manual mode R2	Auto	63
LANG	x	Language	dE	63
UNIT	x	Temperature unit	°C	63
RESE	x	Reset - back to factory settings		63
#####		Version number		

Legend:

Symbol	Description
x	Channel is available
x*	Channel is available, if the corresponding option is activated.

3 Operation and function

3.1 Buttons

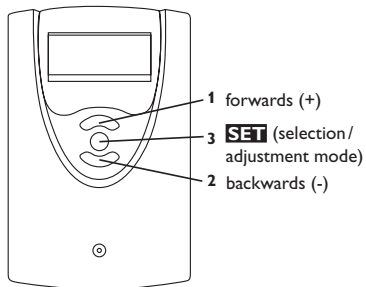

The controller is operated via the 3 push buttons below the display.

Button 1 (+) is used for scrolling forwards through the menu and increasing adjustment values. **Button 2 (-)** is used for scrolling backwards through the menu and reducing adjustment values. **Button 3 (OK)** is used for selecting channels and confirming adjustments.

During normal operation, display channels will be displayed.

→ In order to scroll between display channels, press buttons 1 and 2.

Access to adjustment channels:

→ Use button 1 in order to scroll to the last display channel, then press and hold down button 1 for approx. 2 s.

If an **adjustment channel** is shown on the screen, **SET** will be displayed on the right-hand side next to the channel name.

→ Press button 3 in order to select an adjustment channel.

SET starts flashing.

→ Adjust the desired value with buttons 1 and 2.

→ Briefly press button 3.

SET permanently appears, the adjusted value has been saved.

4 System-Monitoring-Display

System-Monitoring-Display

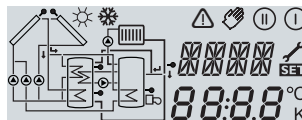

The System-Monitoring-Display consists of 3 blocks: channel display, tool bar and system screen.

Channel display

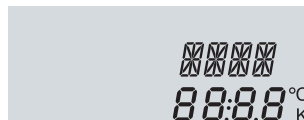

The channel display consists of 2 lines. The upper display line is an alphanumeric 16-segment display. In this line, mainly channel names and menu items are displayed. In the lower 16-segment display, values are displayed.

Tool bar

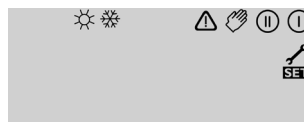

The additional symbols in the tool bar indicate the current system state.

Permanently shown	Flashing	Status indications:
ⓘ		Relay 1 active
Ⓜ		Relay 2 active
☀		Maximum store temperature exceeded
	⚠ + ☀	Store emergency shutdown active
	⚠	Collector emergency shutdown active
ⓘ	☀	Collector cooling active
ⓘ	☀	System cooling active
ⓘ + ☀		Store cooling active
☀	⚠	Holiday cooling option activated
ⓘ + ☀	⚠	Holiday cooling active
	☀	Collector minimum limitation active
☀		Antifreeze function activated
ⓘ / Ⓜ	☀	Antifreeze function active
👤 + ⓘ	⚠	Manual mode relay 1 ON
👤 + Ⓜ	⚠	Manual mode relay 2 ON
👤	⚠	Manual mode relay 1/2 OFF
🔧	⚠	Sensor fault

System screen

The system selected is indicated in the System-Monitoring-Display. It consists of several system component symbols which are – depending on the current status of the system – either flashing, permanently shown or not indicated.

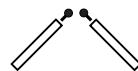
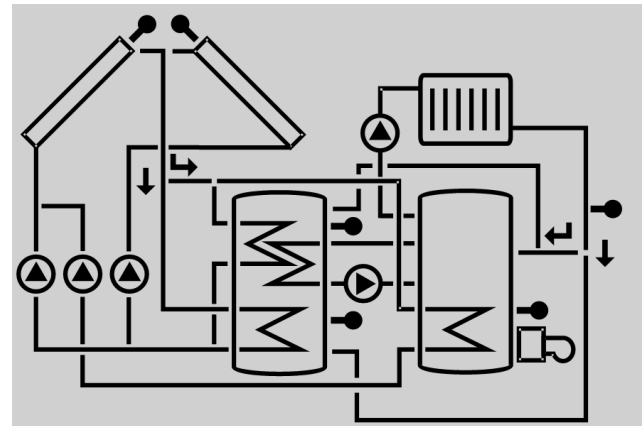

Collectors
with collector sensor

 **Temperature sensor**

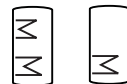

Store
with heat exchanger

 **Heating circuit**

 **Pump**



3-port valve
Only the flow direction or current switching position is indicated.

 **Backup heating**
with burner symbol

4.1 Flashing codes

- Pumps are flashing when the corresponding relay is switched on
- Sensor symbols are flashing, if the corresponding sensor display channel is selected
- Sensors are flashing quickly in the case of a sensor fault
- Burner symbol is flashing if the backup heating is active

5 Commissioning

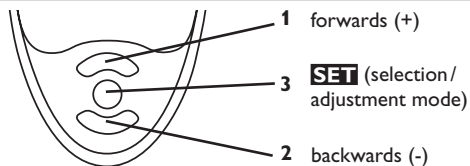

➔ Connect the device to the mains

The controller runs an initialisation phase.

When the controller is commissioned or when it is reset, it will run a commissioning menu. The commissioning menu leads the user through the most important adjustment channels needed for operating the system.

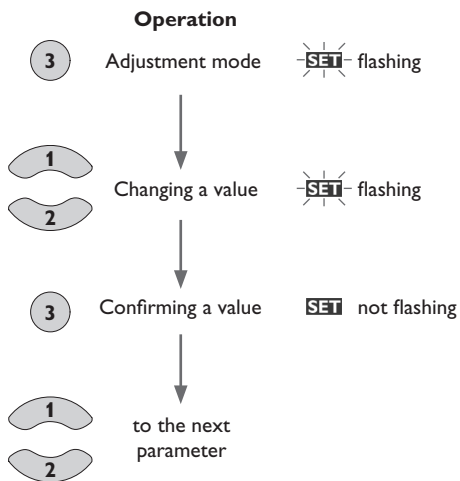

Commissioning

1. Language

➔ Adjust the desired menu language.

LANG

Language selection

Selection: dE, En, Fr, ES, It

Factory setting: dE

2. Temperature unit

➔ Adjust the desired unit.

UNIT

Temperature unit

Selection: °F, °C

Factory setting: °C

3. Time

➔ Adjust the clock time.

First of all adjust the hours, then the minutes.

TIME

Real time clock

4. Arrangement

➔ Adjust the desired system.

For a detailed description of the systems to choose from, see page 8.

Arr

System selection

Adjustment range: 1 ... 10

Factory setting: 1

If the system selection is changed later on, any previous adjustments which have been made in the other channels will be lost. Therefore, changing the system is always followed by a security enquiry.

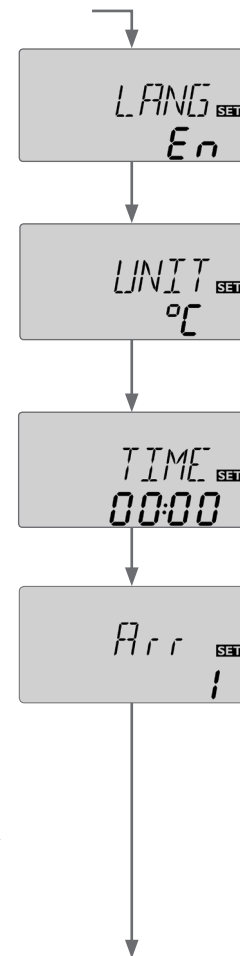

Commissioning

Only confirm the security enquiry if you are sure that you wish to change the system selection.

Security enquiry:

→ In order to confirm the security enquiry, press button 3.

5. Maximum store temperature

→ Adjust the desired maximum store temperature.

S MX / S1MX / S2MX

Maximum store temperature

Adjustment range: 4 ... 95 °C [40 ... 200 °F]

Arr 10: 4 ... 90 °C [40 ... 190 °F]

Factory setting: 60 °C [140 °F]



Note

The controller is also equipped with a non-adjustable emergency shutdown, deactivating the system if the store reaches 95 °C [200 °F].

6. Pump control type

→ Adjust the pump control type.

PUM1 / PUM2

Pump control type

Selection: OnOF, PULS, PSOL, PHEA

Factory setting: PSOL

The following types can be selected:

Adjustment for standard pump without speed control

- OnOF (pump on / pump off)

Adjustment for standard pump with speed control

- PULS (burst control via semiconductor relay)

Adjustment for high-efficiency pump (HE pump)

- PSOL (PWM profile for a HE solar pump)
- PHEA (PWM profile for a HE heating pump)

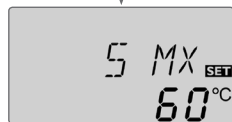

Commissioning

7. Minimum speed

→ Adjust the minimum speed for the corresponding pump.

nMN, n1MN, n2MN

Minimum speed

Adjustment range: (10) 30 ... 100 %

Factory setting: 30 %



Note

The pump speed must be set to 100% when auxiliary relays or valves are connected.

8. Maximum speed

→ Adjust the maximum speed for the corresponding pump.

nMX, n1MX, n2MX

Maximum speed

Adjustment range: (10) 30 ... 100 %

Factory setting: 100 %



Note

The pump speed must be set to 100% when auxiliary relays or valves are connected.

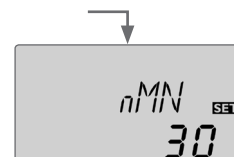

Confirmation

Completing the commissioning menu

After the last channel of the commissioning menu has been adjusted and confirmed, the controller asks for confirmation of the adjustments.

→ In order to confirm the adjustments made in the commissioning menu, press button 3.

The controller is then ready for operation with the adjustments made for the system selected .



Note

The adjustments carried out during commissioning can be changed anytime in the corresponding adjustment channel. Additional functions and options can also be activated or deactivated (see page 46).

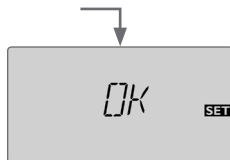

6 Channel overview

6.1 Display channels



Note

The display and adjustment channels as well as the adjustment ranges depend on the system selected, the functions and options as well as on the system components connected to the controller.

Display of drainback time periods

Initialisation

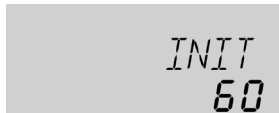

INIT

ODB initialisation active

Indicates the time adjusted in tDTO, running backwards.

Filling time



FLL

ODB filling time active

Indicates the time adjusted in tFLL, running backwards.

Stabilisation

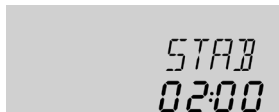

STAB

ODB stabilisation in progress

Indicates the time adjusted in tSTB, running backwards.

Display of collector temperatures



COL, COL1, COL2

Collector temperature

Display range: -40 ... +260 °C [-40 ... +500 °F]

Indicates the collector temperatures.

- COL : Collector temperature (1-collector system)
- COL1 : Collector temperature 1
- COL2 : Collector temperature 2

Display of store temperatures



TST, TSTB, TSTT, TST1, TST2, TDIS

Store temperatures

Display range: -40 ... +260 °C [-40 ... +500 °F]

Indicates the store temperatures.

- TST : Store temperature (1-store system)
- TSTB : Store temperature base
- TSTT : Store temperature top
- TST1 : Store temperature 1 (2-store system)
- TST2 : Store temperature 2 (2-store system)
- TDIS : Thermal disinfection temperature

(Arr = 3 only; replaces TSTT if, during thermal disinfection, the heating period DDIS is active)

Display of sensors 3, 4 and VFD

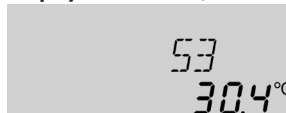

S3, S4, VFD

Sensor temperatures

Display range: -40 ... +260 °C [-40 ... +500 °F]

VFD: 0 ... 100 %

Indicates the current temperature at the corresponding additional sensor (without control function).

- S3 : Temperature at sensor 3
- S4 : Temperature at sensor 4
- VFD : Grundfos Direct Sensor™



Note

S3 and S4 will only be indicated if the temperature sensors are connected to the corresponding terminals. VFD will be indicated only if a Grundfos Direct Sensor™ has been connected and registered.

Display of further temperatures



TFSB, TRET, TFL, TR

Further measured temperatures

Display range: -40 ... +260 °C [-40 ... +500 °F]

Indicates the current temperature at the corresponding sensor. The display of these temperatures depends on the system selected.

- TFSB : Temperature solid fuel boiler
- TRET : Temperature heating circuit return preheating
- TFL : Temperature flow
- TR : Temperature return



Note

TFL/ TR will be indicated only if the heat quantity measurement option (OHQM) has been activated.

Display of flow rate

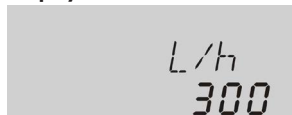

l/h

Flow rate

Display range: depending on the sensor type used

Indicates the current flow rate at the VFD flow rate sensor.

The display range depends on the sensor type previously selected.

Display of current pump speed

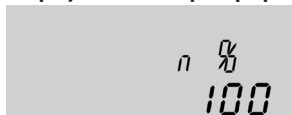

n%, n1%, n2%

Current pump speed

Display range: 30 ... 100%

Indicates the current pump speed of the corresponding pump.

- n% : Current pump speed (1-pump system)
- n1% : Current pump speed pump 1
- n2% : Current pump speed pump 2



kWh/MWh

Heat quantity in kWh/MWh

Display channel

Indicates the energy gained in heat quantity – only available if heat quantity measurement (**OHQM**) is activated.

The heat quantity measurement can be carried out in 2 different ways (see page 60): with a fixed flow rate value or with a VFD Grundfos Direct Sensor™. It is shown in kWh in the channel **kWh** and in MWh in the channel **MWh**. The overall heat quantity results from the sum of both values.

The accumulated heat quantity can be set back to zero. As soon as one of the display channels of the heat quantity is selected, the symbol **SET** is displayed.

→ In order to access the reset mode of the counter, press button 3 for approx. 2 s.

SET starts flashing and the heat quantity value will be set back to zero.

→ In order to finish the reset process, press button 3.

In order to interrupt the reset process, do not press any button for about 5 s. The display returns to the display mode.



CDIS

Countdown monitoring period

Display range: 0 ... 30:0 ... 24 (dd:hh)

If the thermal disinfection option (**OTD**) is activated and the monitoring period is in progress, the remaining time is displayed as **CDIS** (in hours and minutes), counting backwards.

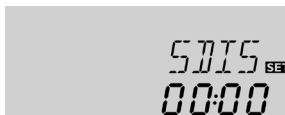

SDIS

Display of starting time

Display range: 00:00 ... 24:00 (hh:mm)

If the thermal disinfection option (**OTD**) is activated and a starting delay time has been adjusted, the adjusted starting time is displayed as **SDIS** (flashing).

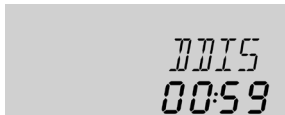

DDIS

Display of heating period

Display range: 00:00 ... 24:00 (hh:mm)

If the thermal disinfection option (**OTD**) is activated and the heating period is in progress, the remaining time is displayed as **DDIS** (in hours and minutes), counting backwards.

6.2 Adjustment channels

System selection



Arr

System selection.

Adjustment range: 1 ... 10

Factory setting: 1

In this channel, a pre-defined system can be selected. Each system has a set of pre-programmed settings that can be individually changed.

If the system selection is changed later on, any previous adjustments which have been made in the other channels will be lost. Therefore, changing the system is always followed by a security enquiry.

Only confirm the security enquiry if you are sure that you wish to change the system selection.



Security enquiry:

→ In order to confirm the security enquiry, press button 3.

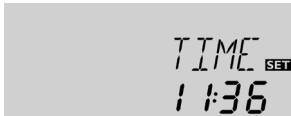

TIME

Indicates the current clock time.

- In order to adjust the hours, press button 3 for approx. 2 s.
- Set the hours by pressing buttons 1 and 2.
- In order to adjust the minutes, press button 3.
- Set the minutes by pressing buttons 1 and 2.
- In order to save the adjustments, press button 3.

Operating hours counter

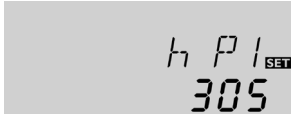

h P/h P1/h P2

Operating hours counter

Display channel

The operating hours counter accumulates the operating hours of the corresponding relay (**hP/h P1/h P2**). Full hours are displayed.

The accumulated operating hours can be set back to zero. As soon as an operating hours channel is selected, the symbol **SET** is displayed.

→ In order to access the reset mode of the counter, press button 3 for approx. 2 s.

SET starts flashing and the operating hours will be set back to zero.

→ In order to finish the reset process, press button 3.

In order to interrupt the reset process, do not press any button for about 5 s. The display returns to the display mode.

ΔT control

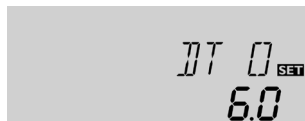

DTO/DT1O/DT2O/DT3O

Switch-on temperature difference

Adjustment range: 1.0 ... 20.0 K [2.0 ... 40.0 °Ra]

Factory setting: 6.0 K [12.0 °Ra]

The controller works as a standard differential controller. If the temperature reaches or exceeds the switch-on temperature difference, the pump switches on.

When the temperature difference reaches or falls below the adjusted switch-off temperature difference, the respective relay switches off.



Note

The switch-on temperature difference must be at least 0.5 K [1 °Ra] higher than the switch-off temperature difference.

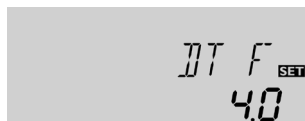

DTF/DT1F/DT2F/DT3F

Switch-off temperature difference

Adjustment range: 0.5 ... 19.5 K [1.0 ... 39.0 °Ra]

Factory setting: 4.0 K [8.0 °Ra]



Note

If the drainback option **ODB** is activated, the values of the parameters **DTO**, **DTF** and **DTS** will be adapted to values suiting drainback systems:

DT O = 10 K [20 °Ra]

DT F = 4 K [8 °Ra]

DTS = 15 K [30 °Ra]

Adjustments that have been previously made in these channels will be overridden and have to be entered again if **ODB** is deactivated later on.

Speed control



DTS/DT1S/DT2S/DT3S

Set temperature difference

Adjustment range:

1.5 ... 30.0 K [3.0 ... 60.0 °Ra]

Factory setting: 10.0 K [20.0 °Ra]



Note

For pump speed control, the operating mode of the corresponding relay must be set to Auto (adjustment channel **MAN1 / MAN2**).

If the temperature difference reaches or exceeds the switch-on temperature difference, the pump switches on at 100% speed for 10 s. Then, the speed is reduced to the minimum pump speed value.

If the temperature difference reaches the adjusted set value, the pump speed increases by one step (10%). The response of the controller can be adapted via the parameter Rise. Each time the difference increases by the adjustable rise value, the pump speed increases by 10% until the maximum pump speed of 100% is reached. If the temperature difference decreases by the adjustable rise value, pump speed will be decreased by one step.



Note

The set temperature difference must be at least 0.5 K [1 °Ra] higher than the switch-on temperature difference.



PUM1 / PUM2

Pump control type

Selection: OnOF, PULS, PSOL, PHEA

Factory setting: PSOL

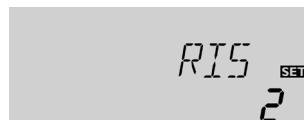

RIS/RIS1/RIS2/RIS3

Rise

Adjustment range:

1 ... 20 K [2 ... 40 °Ra]

Factory setting: 2 K [4 °Ra]

With this parameter, the pump control type can be adjusted. The following types can be selected:

Adjustment for standard pump without speed control

- OnOF (pump on/pump off)

Adjustment for standard pump with speed control

- PULS (burst control via semiconductor relay)

Adjustment for high-efficiency pump (HE pump)

- PSOL (PWM profile for a HE solar pump)
- PHEA (PWM profile for a HE heating pump)

Minimum speed

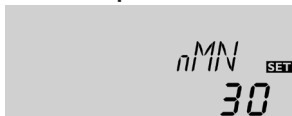

nMN, n1MN, n2MN

Minimum speed

Adjustment range: (10) 30... 100%

Factory setting: 30%

nMN, n1MN, if ODB is activated: 50%

In the adjustment channels **nMN**, **n1MN** and **n2MN** a relative minimum pump speed for connected pumps can be allocated to the outputs R1 and R2.



Note

The pump speed must be set to 100% when auxiliary relays or valves are connected.



nMX, n1MX, n2MX

Maximum speed

Adjustment range: (10) 30... 100%

Factory setting: 100%

In the adjustment channel n1(2)MX a relative maximum speed for connected pumps can be allocated to the outputs R1 and R2.



Note

The pump speed must be set to 100% when auxiliary relays or valves are connected.

Maximum store temperature



S MX/S1MX/S2MX

Maximum store temperature

Adjustment range: 4... 95 °C [40... 200 °F]

Arr 10: 4... 90 °C [40... 190 °F]

Factory setting: 60 °C [140 °F]

If the store temperature reaches the adjusted maximum temperature, the store will no longer be loaded in order to avoid damage caused by overheating. A non-adjustable hysteresis of 2 K [4 °Ra] is set for the maximum store temperature.

If the maximum store temperature is exceeded, ✱ is displayed.



Note

If the collector cooling or the system cooling function is activated, the adjusted maximum store temperature may be exceeded. In order to prevent system damage, the controller is also equipped with an integrated store emergency shutdown, deactivating the system if the store reaches 95 °C [200 °F].

Store emergency shutdown

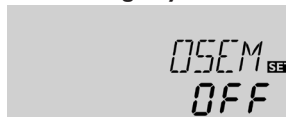

OSEM

Store emergency shutdown option

Adjustment range: ON, OFF

Factory setting: OFF

This option is used for activating the internal store emergency shutdown for an upper store sensor. If the temperature at the reference sensor exceeds 95 °C, store 1 will be blocked and loading will be stopped until the temperature falls below 90 °C.



Note

Sensor S3 is used as the reference sensor in systems 1, 2, 3, 8, 9 and 10. In the systems 6 and 7, sensor S4 is used as the reference sensor. This option is not available in system layouts 4 and 5, in the system layouts 6 and 7 it will only be available if heat quantity measurement is deactivated.

Collector limit temperature Collector emergency shutdown

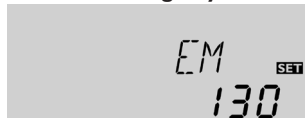

EM/EM1/EM2

Collector limit temperature

Adjustment range: 80 ... 200 °C [170 ... 390 °F]

Factory setting: 130 °C [270 °F]

When the collector temperature exceeds the adjusted collector limit temperature, the solar pump (R1/R2) switches off in order to protect the system components against overheating (collector emergency shutdown). If the collector limit temperature is exceeded, Δ is displayed.



Note

If the drainback option **ODB** is activated, the adjustment range of **EM** will change to 80 ... 120 °C [170 ... 250 °F]. The factory setting in that case is 95 °C [200 °F].

Cooling functions

In the following the 3 cooling functions – collector cooling, system cooling and store cooling – are described in detail. The following notes are valid for all three cooling functions:



Note

The cooling functions will not become active as long as solar loading is possible.



Note

In 2-store-systems, the cooling functions will only affect store 1, or the base area of the store respectively.

Collector cooling

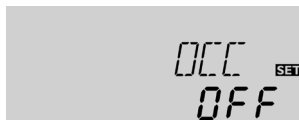

OCC/OCC1/OCC2

Collector cooling option

Adjustment range: OFF/ON

Factory setting: OFF



CMX/CMX1/CMX2

Collector maximum temperature

Adjustment range:

70 ... 160 °C [150 ... 320 °F]

Factory setting: 110 °C [230 °F]

The collector cooling function keeps the collector temperature within the operating range by heating the store. If the store temperature reaches 95 °C [200 °F] the function will switch off for safety reasons.

If the store temperature exceeds the adjusted maximum store temperature, the solar system is switched off. If the collector temperature increases to the adjusted maximum collector temperature, the solar pump is activated until the collector temperature falls below the maximum collector temperature. The store temperature may then exceed the maximum store temperature, but only up to 95 °C [200 °F] (emergency shutdown of the store).

If the collector cooling function is active, \odot and \star are displayed (flashing).



Note

This function will only be available if the system cooling function (**OSYC**) is deactivated.



Note

In system 10, the parameter **CMX** is available without the **OCC** function. In system 10, **CMX** is used for setting the activation temperature for the heat dump function. No other switch-on condition is needed in that case.

System cooling

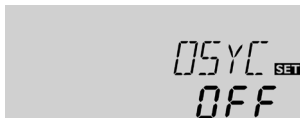

OSYC

System cooling option
Adjustment range: OFF/ON
Factory setting: OFF

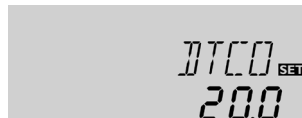

DTCC

Switch-on temperature difference
Adjustment range:
1.0 ... 30.0 K [2.0 ... 60.0 °Ra]
Factory setting: 20.0 K [40.0 °Ra]

The system cooling function aims to keep the solar system operational for a longer time. The function overrides the maximum store temperature to provide thermal relief of the collector field and the heat transfer fluid on hot days. If the store temperature is higher than the adjusted maximum store temperature and the switch-on temperature difference **DTCC** is reached, the solar pump remains switched on or will be switched on. Solar loading is continued until either the temperature difference falls below the adjusted value **DTCCF** or the collector limit temperature is reached. If the system cooling function is active, and are displayed (flashing).

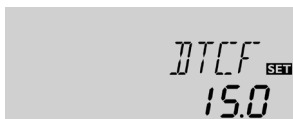

DTCCF

Switch-off temperature difference
Adjustment range: 0.5 ... 29.5 K [1.0 ... 59.0 °Ra]
Factory setting: 15.0 K [30.0 °Ra]



Note

This function will only be available, if the collector cooling function (**OCC**) is deactivated.

Store cooling

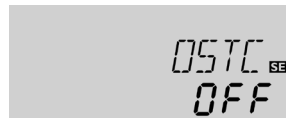

OSTC

Store cooling option
Adjustment range: OFF/ON
Factory setting: OFF



OHOL

Holiday cooling option
Adjustment range: OFF/ON
Factory setting: OFF



THOL

Holiday cooling temperature
Adjustment range: 20 ... 80 °C [70 ... 175 °F]
Factory setting: 40 °C [110 °F]

When the store cooling function is activated, the controller aims to cool down the store during the night in order to prepare it for solar loading on the following day. If the adjusted maximum store temperature (**SMX/S1MX**) is exceeded and the collector temperature falls below the store temperature, the system will be reactivated in order to cool down the store. Cooling will continue until the store temperature has fallen below the adjusted maximum store temperature (**SMX/S1MX**) again. A hysteresis of 2K [4 °Ra] is set for the store cooling function. Reference threshold temperature differences for the store cooling function are **DTO** and **DTF**.

If no DHW consumption is expected for a longer period of time, the additional holiday cooling option **OHOL** can be activated in order to extend the store cooling function. The adjustable temperature **THOL** then replaces the maximum store temperature (**SMX/S1MX**) as the switch-off temperature for the store cooling function.

When the holiday cooling function is activated, and (flashing) are shown on the display.

If the holiday cooling function is active, , and are displayed (flashing).

Collector minimum limitation



OCN/OCN1/OCN2

Collector minimum limitation option

Adjustment range: OFF/ON

Factory setting: OFF



CMN/CMN1/CMN2

Minimum collector temperature

Adjustment range:

10.0... 90.0 °C [50.0... 190.0 °F]

Factory setting: 10.0 °C [50.0 °F]

If the collector minimum limitation option is activated, the pump (R1/R2) will only be switched on, if the adjustable collector minimum temperature is exceeded. The minimum temperature prevents the pump from being switched on too often at low collector temperatures. A hysteresis of 5K [10 °Ra] is set for this function. If the collector minimum limitation is active, ❄️ is displayed (flashing).



Note

If **OSTC** or **OCF** is active, the collector minimum limitation will be overridden. In that case, the collector temperature may fall below **CMN**.

Antifreeze function



OCF/OCF1/OCF2

Antifreeze function option

Adjustment range: OFF/ON

Factory setting: OFF



CFR/CFR1/CFR2

Antifreeze temperature

Adjustment range:

-40.0... +10.0 °C [-40.0... +50.0 °F]

Factory setting: +4.0 °C [+40.0 °F]

The antifreeze function activates the loading circuit between the collector and the store when the temperature falls below the adjusted antifreeze temperature. This will protect the fluid against freezing or coagulating. If the adjusted antifreeze temperature is exceeded by 1K [2 °Ra], the loading circuit will be deactivated.

If the antifreeze function is activated, ❄️ is displayed. If the antifreeze function is active, ⓪ and ❄️ are displayed (flashing).



Note

Since this function uses the limited heat quantity of the store, the antifreeze function should only be used in regions with few days of temperatures around the freezing point.

The antifreeze function will be suppressed if the store temperature falls below +5 °C [+40 °F] in order to protect the store from frost damage.

Priority logic



Note

Priority logic can be used in 2-store system only (Arr = 4, 5, 6).



PRIO

Priority

Adjustment range: SE 1, SE 2, Su 1, Su 2, 0, 1, 2

Factory setting: Arr 4: 2, Arr 5, 6: 1

If a 2-store system has been selected, the priority logic determines how the heat is divided between the stores. Different types of priority logic are adjustable:

- spreaded loading (SE 1 and SE 2)
- successive loading (Su 1 and Su 2)
- parallel loading (0)
- store sequence control (1 and 2)

If priority **PRIO SE 1** or **SE 2** (only available in Arr 6) is adjusted, the subordinate store will be loaded in parallel to the priority store if the temperature difference between the collector and the priority store (store 1 for SE 1, store 2 for SE 2) exceeds the adjusted value **DTSE** and the subordinate store has not reached its maximum temperature.

Parallel loading will stop as soon as the temperature difference between the collector and the priority store falls by 2 K [4 °Ra] below **DTSE** or the subordinate store reaches its maximum temperature.

If priority **PRIO Su 1** or **Su 2** is adjusted, the stores are loaded successively. The subordinate store will only be loaded if the priority store (store 1 for Su 1, store 2 for Su 2) has reached its adjusted maximum temperature (**S1MX** or **S2MX**).

If priority **PRIO 0** is adjusted and the switch-on conditions for both stores are fulfilled, the stores are loaded in parallel (Arr 6) or in store sequence control (Arr 4, 5) respectively, beginning with the store with the lowest temperature. In store sequence control, solar loading will switch from one store to the other in steps of 5 K [10 °Ra] temperature difference between the stores.

If **PRIO 1/2** is adjusted, store sequence control will be activated (see below) with the corresponding store as the priority store.



Note

If the priority is set to **PRIO Su 1** or **Su 2**, solar loading of the subordinate store will be stopped at once if the temperature in the priority store (store 1 for Su 1, store 2 for Su 2) falls below the adjusted maximum temperature. If, in that case, the temperature difference between the priority store and the collector is not sufficiently high, solar loading will be stopped completely.

Spreaded loading temperature difference

(only available if **PRIO** is set to SE 1 or SE 2)

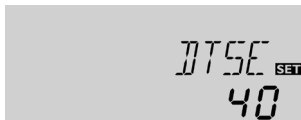

DTSE

Temperature difference spreaded loading

Adjustment range: 20 ... 90 K [40 ... 160 °Ra]

Factory setting: 40 K [70 °Ra]

Store sequence control (only available if priority is set to **PRIO SE 1, SE 2, 1 or 2**)



tLB

Loading break store sequence control

Adjustment range: 1 ... 30 min

Factory setting: 2 min

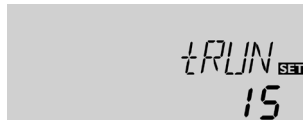

tRUN

Circulation runtime store sequence control

Adjustment range: 1 ... 30 min

Factory setting: 15 min

Store sequence control will be activated when **PRIO** is set to SE1, SE2, 1 or 2.

If the priority store cannot be loaded, the subordinate store will be checked. If useful heat can be added to the subordinate store, it will be loaded for the circulation time (**tRUN** – factory setting 15 min). After this, the loading process stops and the controller monitors the increase in collector temperature during the loading break time **tLB**. If it increases by 2 K [4 °Ra], the break time timer starts again to allow the collector to gain more heat. If the collector temperature does not increase sufficiently, the subordinate store will be loaded again for the **tRUN** runtime as before.

As soon as the switch-on condition of the priority store is fulfilled, it will be loaded. If the switch-on condition of the priority store is not fulfilled, loading of the subordinate store will be continued. If the priority store reaches its maximum temperature, store sequence control will not be carried out.

If store sequence control is active and the system switches to load the priority store, the parameter **tLB** also acts as a stabilisation time, during which the switch-off condition **DTF** is ignored while the system operation is stabilising.

Tube collector function



OTC

Tube collector option

Adjustment range: OFF/ON

Factory setting: OFF



TCST

Tube collector function starting time

Adjustment range: 00:00 ... 23:45

Factory setting: 07:00

This function is used for improving the switch-on behaviour in systems with non-ideal sensor positions (e.g. with some tube collectors). This function operates within an adjusted time frame. It activates the collector circuit pump for an adjustable runtime between adjustable standstill intervals in order to compensate for the delayed temperature measurement.

If the runtime is set to more than 10 s, the pump will be run at 100% for the first 10 s of the runtime. For the remaining runtime, the pump will be run at the adjusted minimum speed. If the collector sensor is defective or the collector is blocked, this function is suppressed or switched off.



TCEN SET
19:00

TCEN

Tube collector function ending time
Adjustment range: 00:00 ... 23:45
Factory setting: 19:00



TCIN SET
30

TCIN

Tube collector function standstill interval
Adjustment range: 1 ... 60 min
Factory setting: 30 min

In system 7 both collectors are operated independently from each other by means of this function. If the store is being loaded by one collector, the other one is nevertheless operated.

**Note**

If the drainback option **ODB** is activated, **TRCU** will not be available. In that case, the runtime will be determined by the parameters **tFLL** and **tSTB**.

Grundfos Direct Sensor™ registration

GFD SET
OFF

GFD

Grundfos Direct Sensor™ registration
Selection: OFF, 12, 40, 40F
Factory setting: OFF
Registration of a digital flow rate sensor which can be used for heat quantity measurement.

OFF : no Grundfos Direct Sensor™

12 : VFD 1-12 (water/propylene glycol mixture)

40 : VFD 2-40

40F : VFD 2-40 Fast (water only)



TRCU SET
30

TRCU

Tube collector function runtime
Adjustment range: 5 ... 500 s
Factory setting: 30 s

Heat quantity measurement

OHQM SET
OFF

OHQM

Heat quantity measurement option
Adjustment range: OFF/ON
Factory setting: OFF

If **OHQM** is activated, the heat quantity gained can be calculated and displayed.

The heat quantity measurement can be carried out in 2 different ways (see below): with a fixed flow rate value or with a VFD Grundfos Direct Sensor™.

Heat quantity measurement with fixed flow rate value

The heat quantity balancing (estimation) uses the difference between the flow and return temperatures and the entered flow rate (at 100% pump speed).

- ➔ Read the flow rate (l/min) and adjust it in the **FMAX** channel.
- ➔ Adjust the antifreeze type and concentration of the heat transfer fluid in the channels **MEDT** and **MED%**.

**Note**

Heat quantity measurement is not possible in systems with 2 solar pumps.



FMAX SET
6.0

FMAX

Flow rate in l/min
Adjustment range: 0.5 ... 100.0
Factory setting: 6.0

**Note:**

The FMAX channel will be available only if the SEN channel has been set to OFF or if no VFD Grundfos Direct Sensor™ is activated.

Heat quantity measurement with a VFD Grundfos Direct Sensor™

Heat quantity measurement with a VFD Grundfos Direct Sensor™ is possible in all system layouts.

In order to use a VFD Grundfos Direct Sensor™ for heat quantity measurement, proceed as follows:

- ➔ Register the VFD Grundfos Direct Sensor™ in the **GFD** channel.
- ➔ Adjust the position of the **VFD** Grundfos Direct Sensor™ in the **SEN** channel.
- ➔ Adjust the type and concentration of the heat transfer fluid in the channels **MEDT** and **MED%**.



SEN

Digital flow rate sensor (only if SEN = 12, 40 or 40F)

Selection: OFF, 1, 2

Factory setting: 2

Flow rate detection type:

OFF : fixed flow rate value (flowmeter)

1 : Grundfos Direct Sensor™ in the flow pipe

2 : Grundfos Direct Sensor™ in the return pipe

Sensor allocation for heat quantity measurement:

SEN	1		2		OFF	
	Arr	SFL	SRET	SFL	SRET	SFL
1	GFD	S4	S4	GFD	S1	S4
2	---	---	S1	GFD	---	---
3	GFD	S4	S4	GFD	S1	S4
4	GFD	S4	S4	GFD	S1	S4
5	GFD	S4	S4	GFD	S1	S4
6	GFD	S4	S4	GFD	---	---
7	GFD	S4	S4	GFD	---	---
8	---	---	S1	GFD	---	---
9	---	---	S1	GFD	---	---
10	GFD	S4	S4	GFD	S1	S4



MEDT

Heat transfer fluid

Adjustment range: 0 ... 3

Factory setting: 1



MED%

Antifreeze concentration

in Vol-% (MED% is not indicated when MEDT 0 or 3 is used.)

Adjustment range: 20 ... 70%

Factory setting: 45%

Heat transfer fluid:

0 : Water

1 : Propylene glycol

2 : Ethylene glycol

3 : Tyfocor® LS/G-LS



Note

If the system 10 has been selected and **OHQM** is activated, heat quantity measurement will be interrupted when the 3-port valve switches to the heat dump. Heat quantity measurement with a VFD Grundfos Direct Sensor™ will continue independently.

Drainback option



Note

A drainback system requires additional components such as a holding tank. The drainback option should only be activated if all components required are properly installed.



Note

The drainback option is only available in system with one store and one collector (Arr 1, 2, 3, 8 and 9).

In a drainback system the heat transfer fluid will flow into a holding tank if solar loading does not take place. The drainback option initiates the filling process if solar loading is about to start. If the drainback option is activated, the following adjustment can be made.

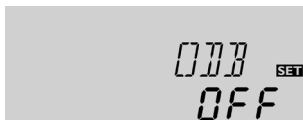
**ODB**

Drainback option

Adjustment range: OFF/ON

Factory setting: OFF

**Note**

If the drainback option is activated, the cooling functions and the antifreeze function will not be available. If one or more than one of these functions have been activated before, they will be deactivated again as soon as **ODB** is activated. They will remain deactivated, even if **ODB** is deactivated later on.

**Note**

If the drainback option **ODB** is activated, the factory settings of the parameters **nMN/n1MN**, **DTO**, **DTF** and **DTS** will be adapted to values suiting drainback systems:

Additionally, the adjustment range and the factory setting of the collector emergency shutdown will change. Adjustments previously made in these channels will be overridden and have to be entered again if the drainback option is deactivated later on.

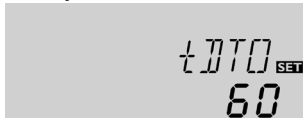
Time period – switch-on condition**tDTO**

Time period – switch-on condition

Adjustment range: 1 ... 100 s

Factory setting: 60 s

The parameter **tDTO** is used for adjusting the time period during which the switch-on condition must be permanently fulfilled.

Filling time**tFLL**

Filling time

Adjustment range: 1.0 ... 30.0 min

Factory setting: 5.0 min

The parameter **tFLL** is used for adjusting the filling time. During this period, the pump runs at 100% speed.

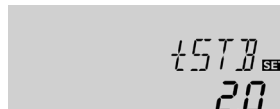
Stabilisation**tSTB**

Stabilisation

Adjustment range: 1.0 ... 15.0 min

Factory setting: 2.0 min

The parameter **tSTB** is used for adjusting the time period during which the switch-off condition will be ignored after the filling time has ended.

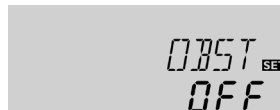
Booster function**OBST option**

Booster function

Adjustment range: ON/OFF

Factory setting: OFF

This function is used for switching on a second pump when filling the solar system. When solar loading starts, R2 is energised in parallel to R1. After the filling time has elapsed, R2 switches off.

**Note**

The booster function is available in system 1 only. The booster function will only be available if the drainback option has been activated.

Operating mode

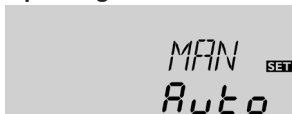

MAN1/MAN2

Operating mode

Adjustment range: OFF,Auto, On

Factory setting: Auto

For control and service work, the operating mode of the relays can be manually adjusted. For this purpose, select the adjustment value **MAN1** (for R1) or **MAN2** (for R2) in which the following adjustments can be made:

• MAN1/MAN2

Operating mode

OFF : Relay off Δ (flashing) + ☞

Auto : Relay in automatic operation

ON : Relay on Δ (flashing) + ☞ + ① / ②



Note

Always adjust the operating mode back to **Auto** when the control and service work is completed. Normal operation is not possible in manual mode.

Language



LANG

Language selection

Selection: dE, En, Fr, ES, It

Factory setting: dE

In this adjustment channel the menu language can be selected.

- dE : German
- En : English
- Fr : French
- ES : Spanish
- It : Italian

Unit



UNIT

Temperature unit selection

Selection: °F, °C

Factory setting: °C

In this adjustment channel, the display unit for temperatures and temperature differences can be selected. The unit can be switched between °C/K and °F/°Ra during operation.

Temperatures and temperature differences in °F and °Ra are displayed without units. If the indication is set to °C, the units are displayed with the values.

Reset



RESE

Reset function

By means of the reset function, all adjustments can be set back to their factory settings.

➔ In order to carry out a reset, press button 3

All adjustments that have previously been made will be lost! For this reason, a security enquiry will appear after the reset function has been selected.

Only confirm the security enquiry if you are sure you want to set back all adjustment to the factory setting.

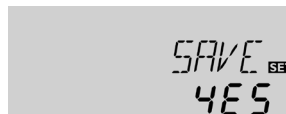

Security enquiry

➔ In order to confirm the security enquiry, press button 3





Note

After a reset, the commissioning menu will start again (see page 48).

7 Troubleshooting

If a malfunction occurs, the display symbols will indicate an error code:

The symbol  is indicated on the display and the symbol  is flashing.

Sensor fault. An error code instead of a temperature is shown on the sensor display channel.

888.8

- 88.8

Cable is broken. Check the cable.

Short circuit. Check the cable.

Disconnected Pt1000 temperature sensors can be checked with an ohmmeter. Please check the resistance values correspond with the table.

°C	°F	Ω	°C	°F	Ω
-10	14	961	55	131	1213
-5	23	980	60	140	1232
0	32	1000	65	149	1252
5	41	1019	70	158	1271
10	50	1039	75	167	1290
15	59	1058	80	176	1309
20	68	1078	85	185	1328
25	77	1097	90	194	1347
30	86	1117	95	203	1366
35	95	1136	100	212	1385
40	104	1155	105	221	1404
45	113	1175	110	230	1423
50	122	1194	115	239	1442

Resistance values of Pt1000 sensors

The display is permanently off.

If the display is off, check the power supply of the controller. Is it disconnected?

no

yes

The fuse of the controller could be blown. The fuse holder (which holds the spare fuse) becomes accessible when the cover is removed. The fuse can then be replaced.

Check the supply line and reconnect it.

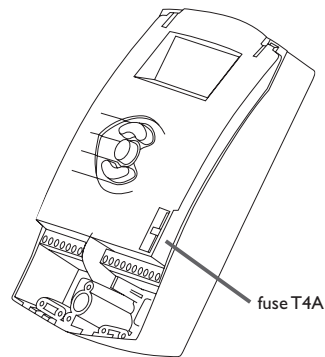

Pump is overheated, but no heat transfer from the collector to the store, flow and return have the same temperature; perhaps also bubbling in the lines.

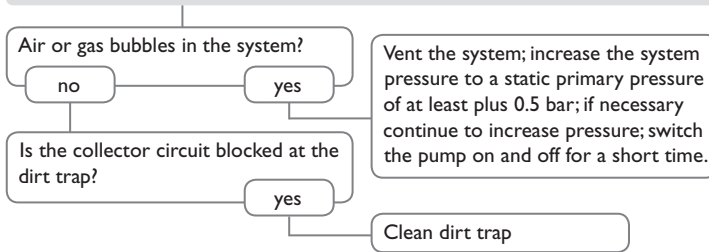

Pump starts up very late.

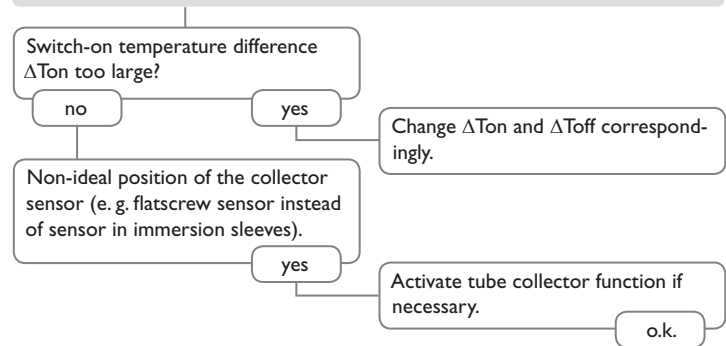

Pump starts for a short moment, switches off, switches on again, etc.

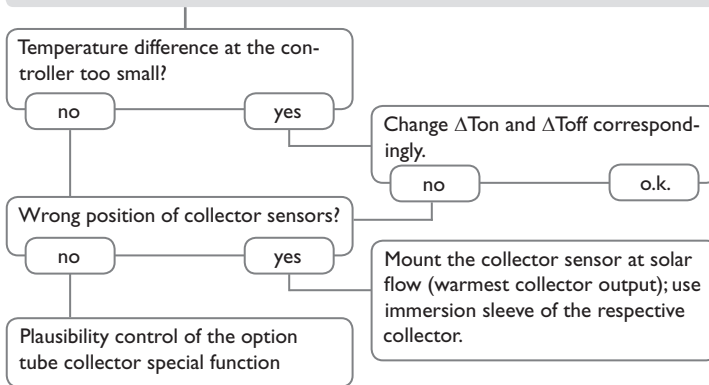

The temperature difference between store and collector increases enormously during operation; the collector circuit cannot dissipate the heat.

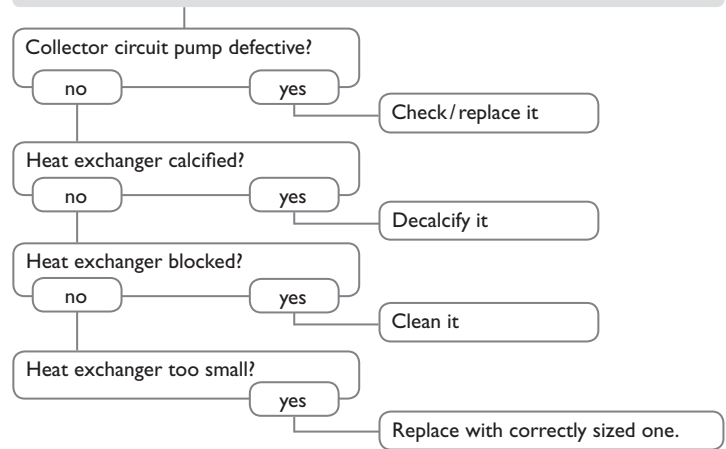

Note:

For answers to frequently asked questions (FAQ) see www.resol.com.

Stores cool down at night

Collector circuit pump runs during the night?

no yes

Check controller

Collector temperature at night is higher than the outdoor temperature.

no yes

Check the non-return valves in the flow and the return pipe for functional efficiency.

Sufficient store insulation?

yes no

Increase insulation.

Insulation close enough to the store?

yes no

Replace insulation or increase it.

Are the store connections insulated?

yes no

Insulate the connections.

Warm water outflow upwards?

no yes

Change connection and let the water flow sideways or through a siphon (downwards); less store losses now?

no o.k. yes

Does the DHW circulation run for a very long time?

no yes

Use the circulation pump with timer and switch-off thermostat (energy-efficient circulation).

Circulation pump and blocking valve should be switched off for 1 night; less store losses?

yes no

Check whether the pumps of the after-heating circuit run at night; check whether the non-return valve is defective; problem solved?

no

a

b

a

Check the non-return valve in warm water circulation - o.k.

yes no

The gravitation circulation in the circulation line is too strong; insert a stronger valve in the non-return valve or an electrical 2-port valve behind the circulation pump; the 2-port valve is open when the pump is activated,

b

Further pumps which are connected to the solar store must also be checked.

Clean or replace it.

otherwise it is closed; connect pump and 2-port valve electrically in parallel; activate the circulation again. Deactivate pump speed control!

The solar circuit pump does not work, although the collector is considerably warmer than the store

Is the display working?

yes no

There is no current; check fuses / replace them and check power supply.

Does the pump start up in manual operation?

no yes

The adjusted temperature difference for starting the pump is too high; choose a value which makes more sense.

Is the pump current enabled by the controller?

no yes

Is the pump stuck?

yes

Controller fuse ok?

no yes

Turn the pump shaft using a screwdriver; now passable?

no

Replace fuse

Controller might be defective - replace it.

Pump is defective - replace it.



Sensors



SP10 Overvoltage protection device



VFD Grundfos Direct Sensor™



VBus® / USB & VBus® / LAN interface adapters



DeltaSol™ CS Plus



SD3 Smart Display / GA3 Large Display



AM1 Alarm Module



DL2 Datalogger



DL3 Datalogger



8.1 Sensors and measuring instruments

Temperature sensors

The product range includes high-precision platinum temperature sensors, flatscrew sensors, outdoor temperature sensors, indoor temperature sensors, cylindrical clip-on sensors, also as complete sensors with immersion sleeve.

Order information can be found in our catalogue and on our Web site.

SP10 Overvoltage protection device

In order to avoid overvoltage damage at collector sensors (e.g. caused by local lightning storms), we recommend installing the overvoltage protection SP10.

VFD Grundfos Direct Sensors™

The VFD Grundfos Direct Sensor™ is a digital sensor that measures both temperature and flow rate.

8.2 VBus® accessories

SD3 Smart Display

The Smart Display is designed for simple connection to controllers with VBus®. It is used for visualising data issued by the controller: collector temperature, store temperature and energy yield of the solar thermal system. The use of high-efficiency LEDs and filter glass assures a high optical brilliance. An additional power supply is not required.

GA3 Large display module

The GA3 is a completely mounted large display module for visualisation of collector- and store temperatures as well as the heat quantity yield of the solar system via one 6-digit and two 4-digit 7-segment-displays. An easy connection to all controllers with VBus® is possible. The front plate is made of antireflective filterglass and is printed with a light-resistant UV-lacquering. The universal VBus® allows the parallel connection of 8 large displays as well as additional VBus® modules.

AM1 Alarm Module

The AM1 Alarm Module is designed to signal system failures. It is to be connected to the VBus® of the controller and issues an optical signal via the red LED if a failure has occurred. The AM1 also has a relay output, which can e. g. be connected to a building management system (BMS). Thus, a collective error message can be issued in the case of a system failure.

The AM1 Alarm module ensures that occurring failures can be immediately recognised and repaired, even if the system and the controller are difficult to access or located in a remote place. Thus, the reliability and the stable yield of the system are ensured.

DL2 Datalogger

This additional module enables the acquisition and storage of large amounts of data (such as measuring and balance values of the solar system) over a long period of time. The DL2 can be configured and read-out with a standard Internet browser via its integrated web interface. For transmission of the data stored in the internal memory of the DL2 to a PC, an SD card can be used. The DL2 is appropriate for all controllers with VBus®. It can be connected directly to a PC or router for remote access and thus enables comfortable system monitoring for yield monitoring or for diagnostics of faults.

DL3 Datalogger

Be it solar thermal, heating or DHW heat exchange controllers – with the DL3 you can easily and conveniently log system data of up to 6 controllers. Get a comprehensive overview of all controllers connected with the large full graphic display. Transfer data with an SD memory card, or use the LAN interface to view and process data on your PC.

VBus.net

The Internet portal for easy and secure access to your system data.

VBus.net is all about the data of your RESOL controller. Live data of your system, customized filter settings and much more await you.

8.3 Interface adapters

VBus®/USB interface adapter

The VBus®/USB interface adapter is the interface between the controller and a personal computer. With its standard mini USB port it enables a fast transmission of system data for processing, visualising and archiving as well as the parametrisation of the controller via the VBus®. The ServiceCenter software is included.

VBus®/LAN interface adapter

The VBus®/LAN interface adapter is designed for the direct connection of the controller to a PC or router. It enables easy access to the controller via the local network of the owner. Thus, controller access, system parameterisation and data charting can be effected from every workstation of the network. The VBus®/LAN interface adapter is suitable for all controllers equipped with a VBus®. The ServiceCenter software is included.

A		M	
Accessories.....	67, 68	Minimum collector temperature	58
Antifreeze function	58	Monitoring-Display	46
B		Mounting.....	5
backup heating.....	20	O	
Booster function	62	Operating mode.....	63
C		P	
Collector cooling	56	Priority logic.....	58
Collector emergency shutdown.....	56	R	
Commissioning.....	48	Return preheating.....	51
Cooling function.....	56	S	
D		Speed control.....	54
ΔT control.....	54	Spreaded loading	59
Data communication / Bus.....	6	Store cooling.....	57
Displays.....	46	Store sequence control	59
Drainback option	61	System overview	7
E		System screen.....	47
Electrical connection.....	5	T	
F		Technical data.....	4
Flow rate.....	52, 60	Thermal disinfection.....	21
H		Thermostat function	20
Heat quantity measurement.....	60	Time.....	48
Holiday.....	57	Troubleshooting.....	64
L			
Language.....	63		

Distributed by:

RESOL – Elektronische Regelungen GmbH

Heiskampstraße 10
45527 Hattingen / Germany

Tel.: +49 (0) 23 24 / 96 48 - 0

Fax: +49 (0) 23 24 / 96 48 - 755

www.resol.com
info@resol.com

Important note

The texts and drawings in this manual are correct to the best of our knowledge. As faults can never be excluded, please note:

Your own calculations and plans, under consideration of the current standards and directions should only be basis for your projects. We do not offer a guarantee for the completeness of the drawings and texts of this manual - they only represent some examples. They can only be used at your own risk. No liability is assumed for incorrect, incomplete or false information and / or the resulting damages.

Note

The design and the specifications can be changed without notice.

The illustrations may differ from the original product.

Imprint

This mounting- and operation manual including all parts is copyrighted. Another use outside the copyright requires the approval of **RESOL – Elektronische Regelungen GmbH**. This especially applies for copies, translations, micro films and the storage into electronic systems.